

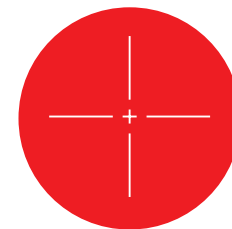

Digital Night Vision Riflescopes

DIGISIGHT **ULTRA N400th**

N450 | N450 LRF | N455 | N455 LRF



**Reticle
Catalogue**

Non-scalable reticles

The values of the non-scalable reticles are correct in the following cases:

- when the magnification of the scope is set to minimum
- when "picture in picture" is activated

D50i

C50i

X54i

H50i

X50i

T54i

M58i

Scalable reticles

Reticle parameters apply to all magnifications

X51Fi-300

M56Fi (Mil-Dot)

M57Fi (Mil-Dot)

Digital Night Vision Riflescopes

DIGISIGHT
ULTRA N400th





D50i

Reticle parameters (for 4.5x magnification)

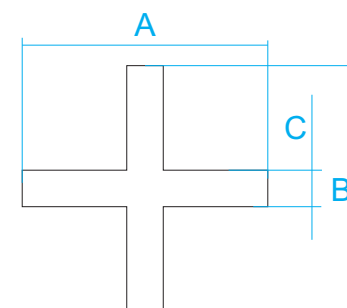

	MOA	cm @ 100 m
Section A	2.4	7
Section B	2.4	7
Section C	0.3	1

C50i

Reticle parameters (for 4.5x magnification)

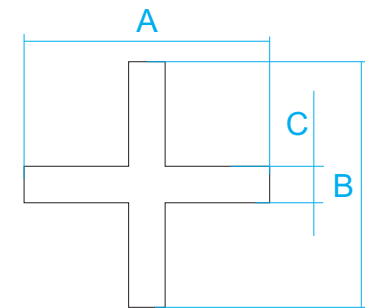
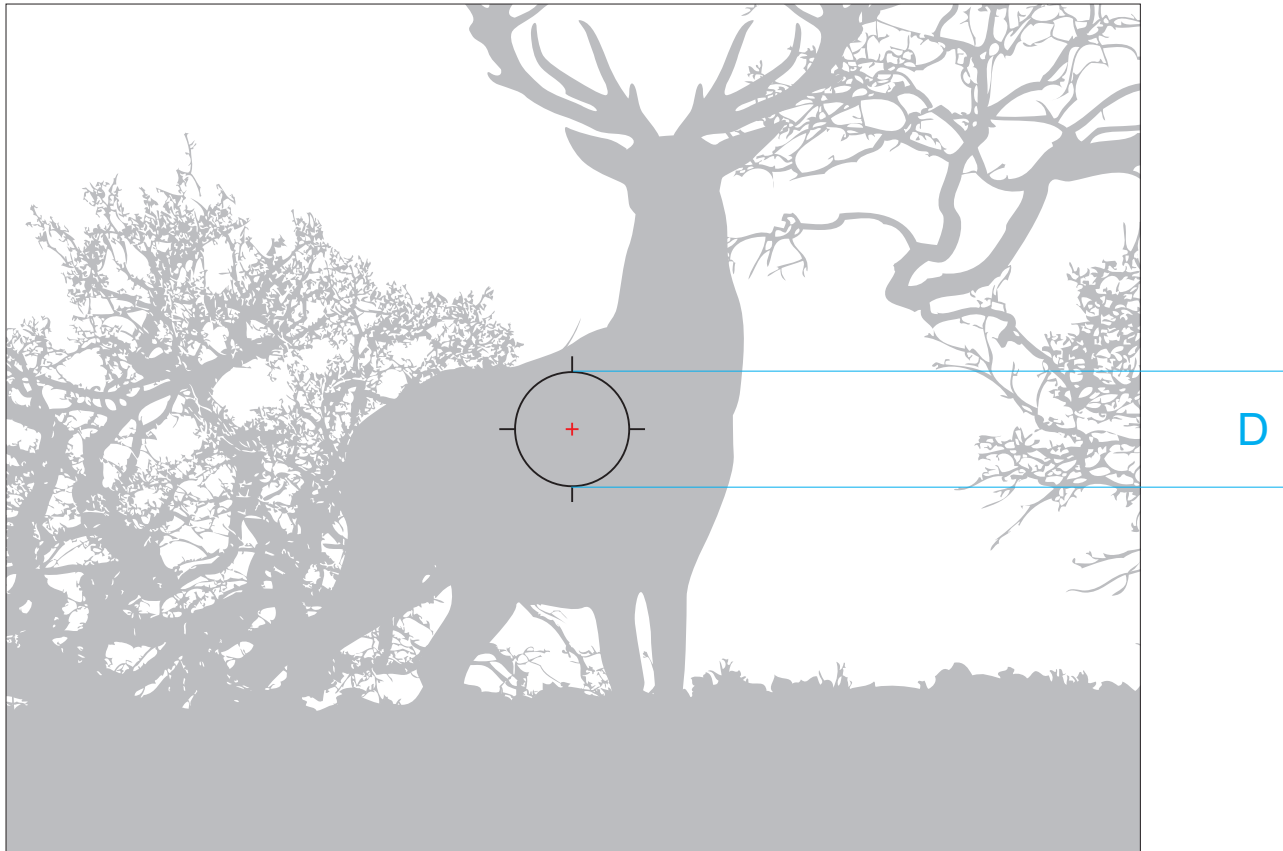

	MOA	cm @ 100 m
Section A	2.4	7
Section B	2.4	7
Section C	0.3	1
Section D	34.4	100

X54i

Reticle parameters (for 4.5x magnification)

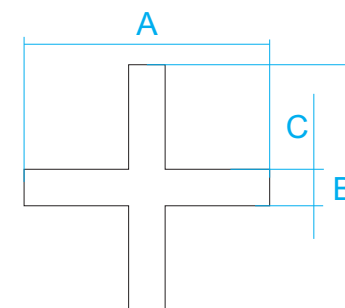
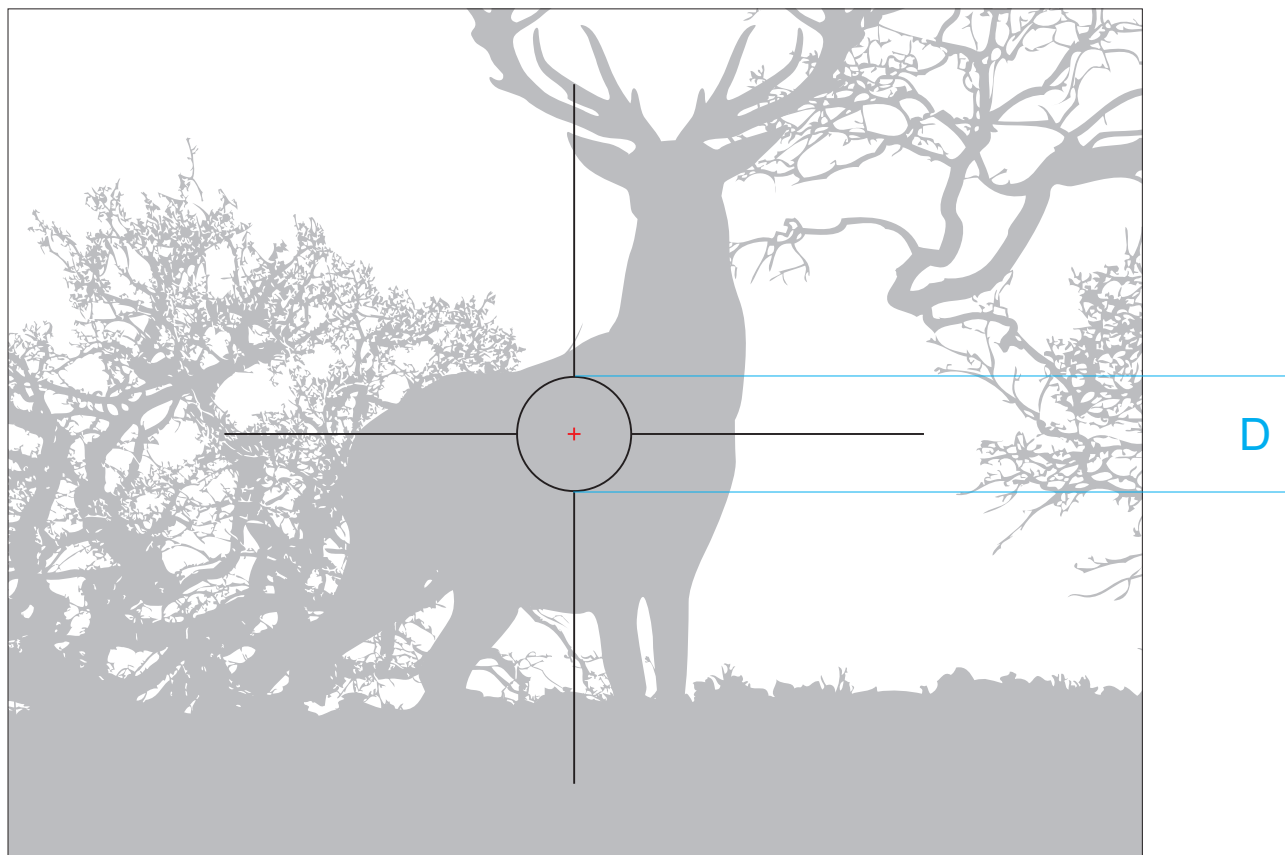

	MOA	cm @ 100 m
Section A	2.4	7
Section B	2.4	7
Section C	0.3	1
Section D	34.4	100

H50i

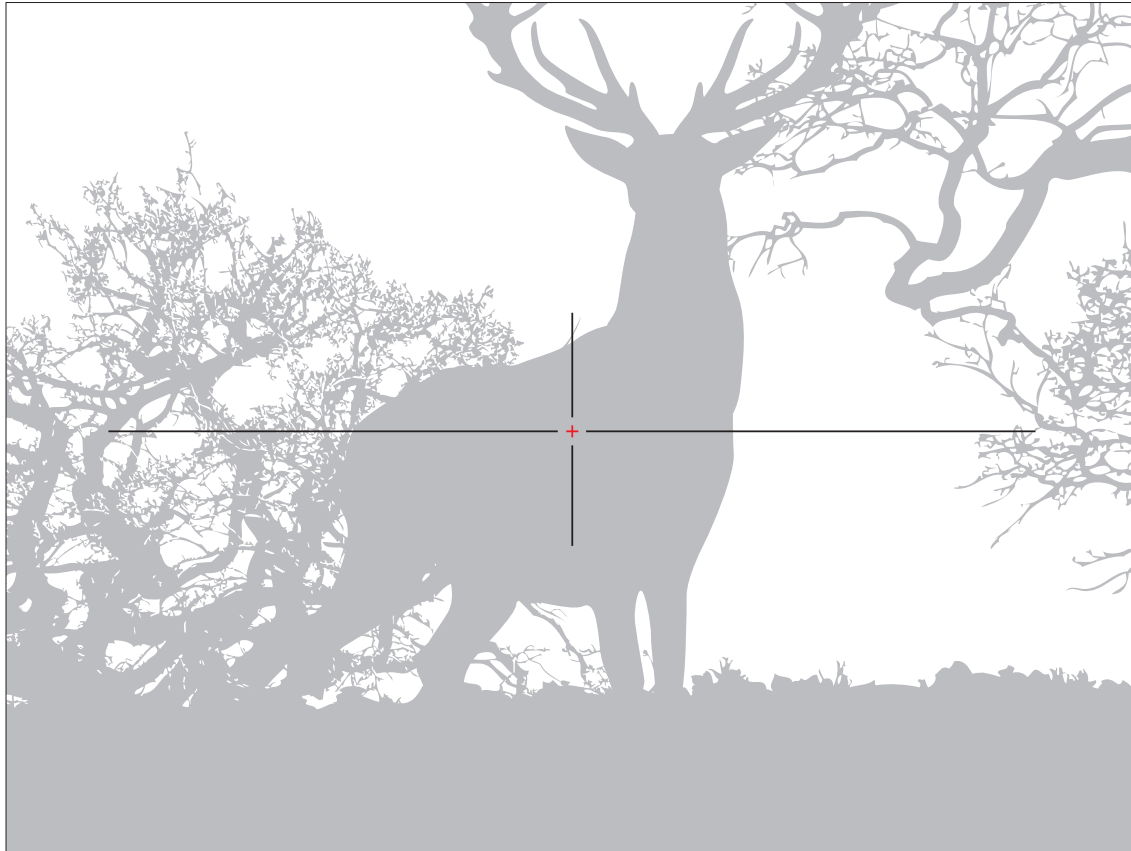

Reticle parameters (for 4.5x magnification)

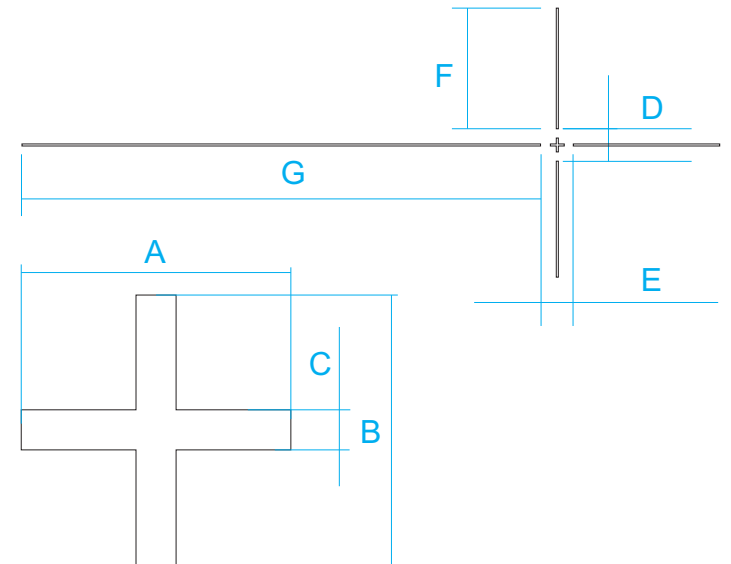

	MOA	cm @ 100 m
Section A	2.4	7
Section B	2.4	7
Section C	0.3	1
Section D	10	29
Section E	10	29
Section F	31.3	91
Section G	110	320

Digital Night Vision Riflescopes
DIGISIGHT
ULTRA N400th

X50i



Reticle parameters (for 4.5x magnification)

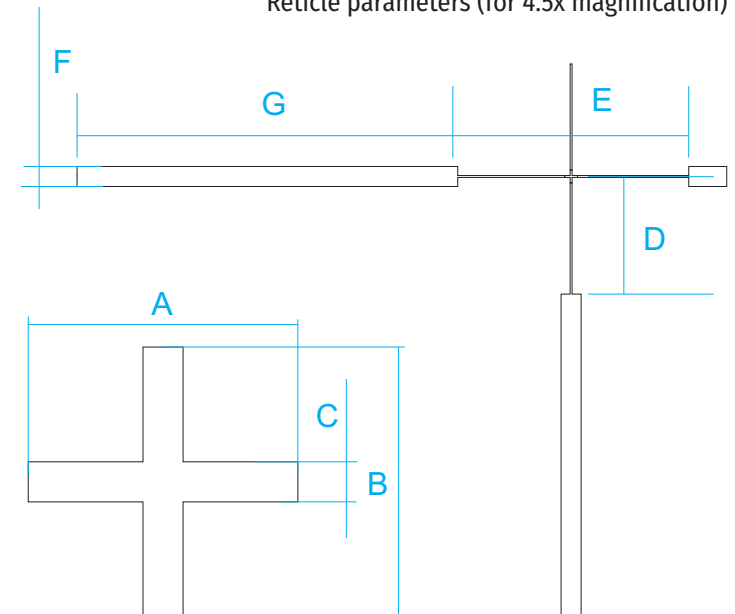

	MOA	cm @ 100 m
Section A	2.4	7
Section B	2.4	7
Section C	0.3	1
Section D	17,2	50
Section E	34,4	100
Section F	1	3
Section G	90	262

Digital Night Vision Riflescopes
DIGISIGHT
ULTRA N400th

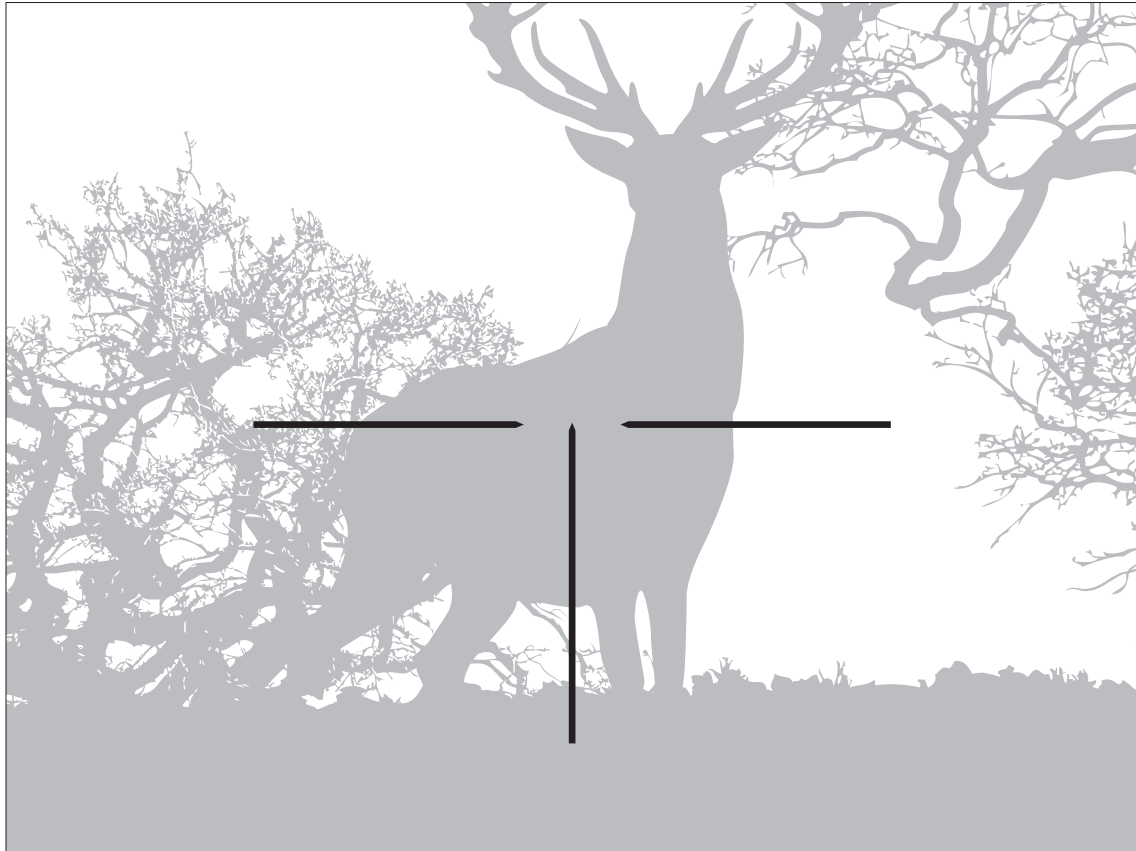

T54i

Reticle parameters (for 4.5x magnification)

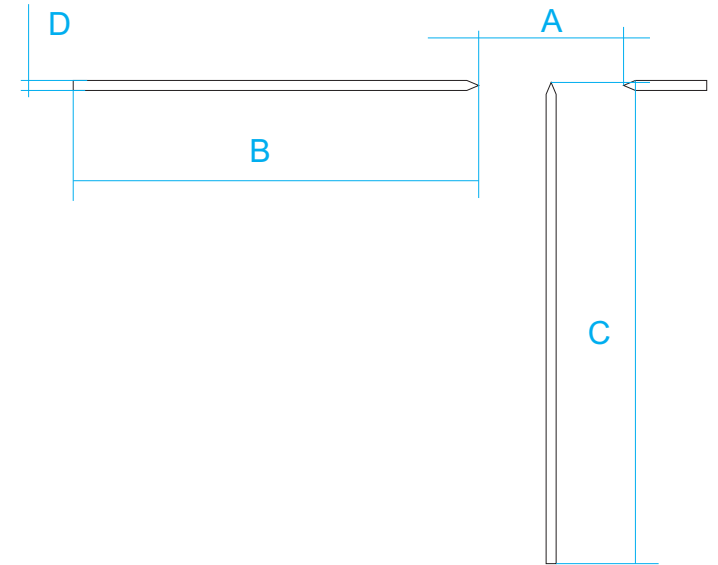

	MOA	cm @ 100 m
Section A	34,4	100
Section B	85	247
Section C	108.8	317
Section D	2.4	7

Digital Night Vision Riflescopes

DIGISIGHT
ULTRA N400th

M58i

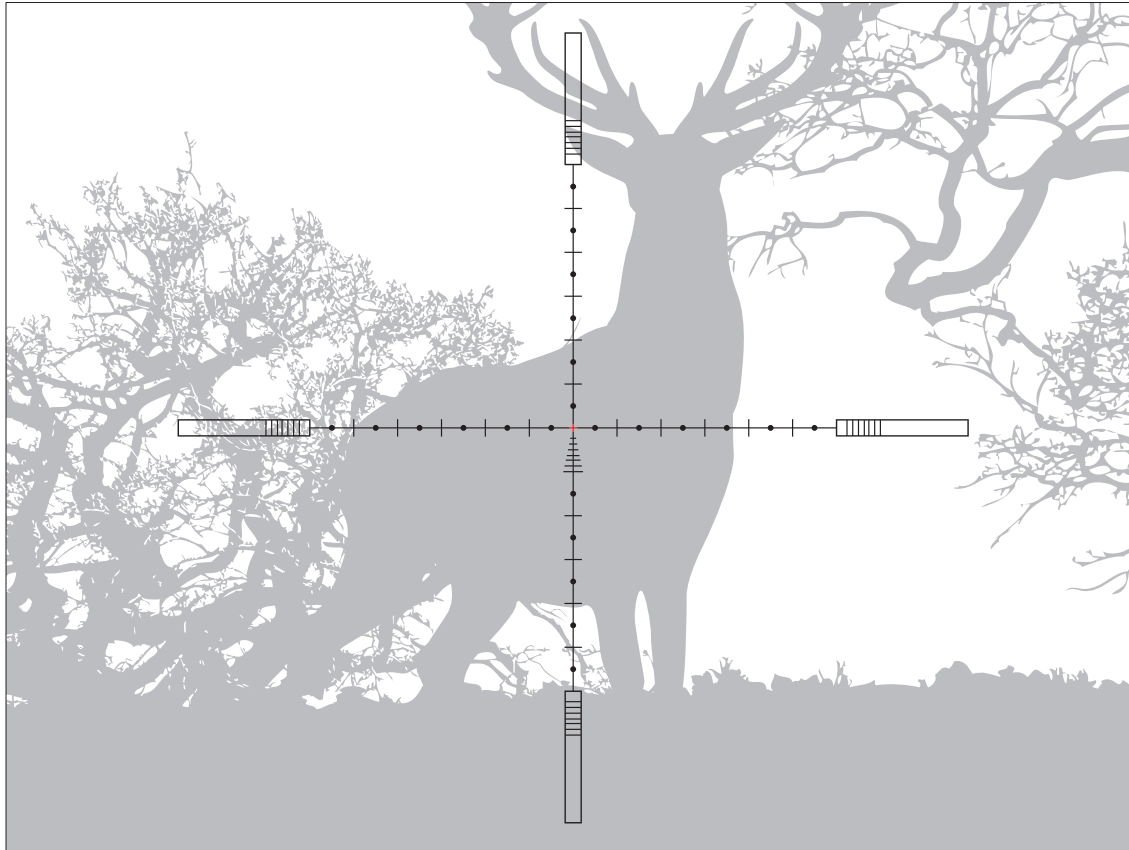

Digital Night Vision Riflescopes
DIGISIGHT
ULTRA N400th

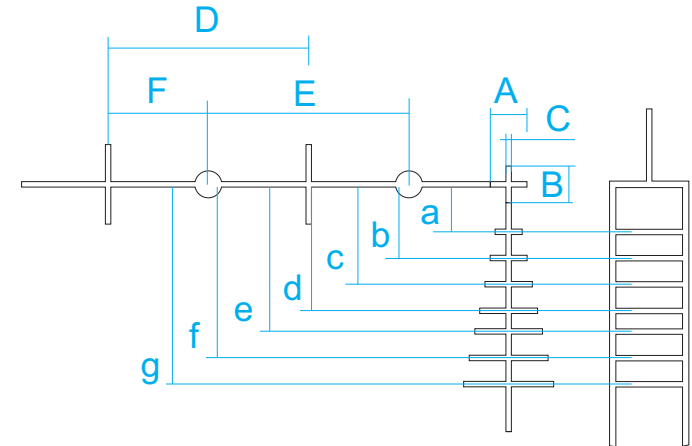

	MOA	cm @ 100 m
Section A	2.4	7 On minimal magnification
Section B	2.4	7 On minimal magnification
Section C	0.3	1 On minimal magnification
Section D	3.5	10 (1 mil) On 18x magnification
Section E	3.5	10 (1 mil) On 18x magnification
Section F	3.5	10 (1 mil) On 9x magnification

Section a: 1 mil (10 cm @ 100 m) on 4.5x magnification

Section b: 1 mil (10 cm @ 100 m) on 7x magnification

Section c: 1 mil (10 cm @ 100 m) on 9x magnification

Section d: 1 mil (10 cm @ 100 m) on 12x magnification

Section e: 1 mil (10 cm @ 100 m) on 14x magnification

Section f: 1 mil (10 cm @ 100 m) on 16x magnification

Section g: 1 mil (10 cm @ 100 m) on 18x magnification

SCALABLE

X51Fi-300

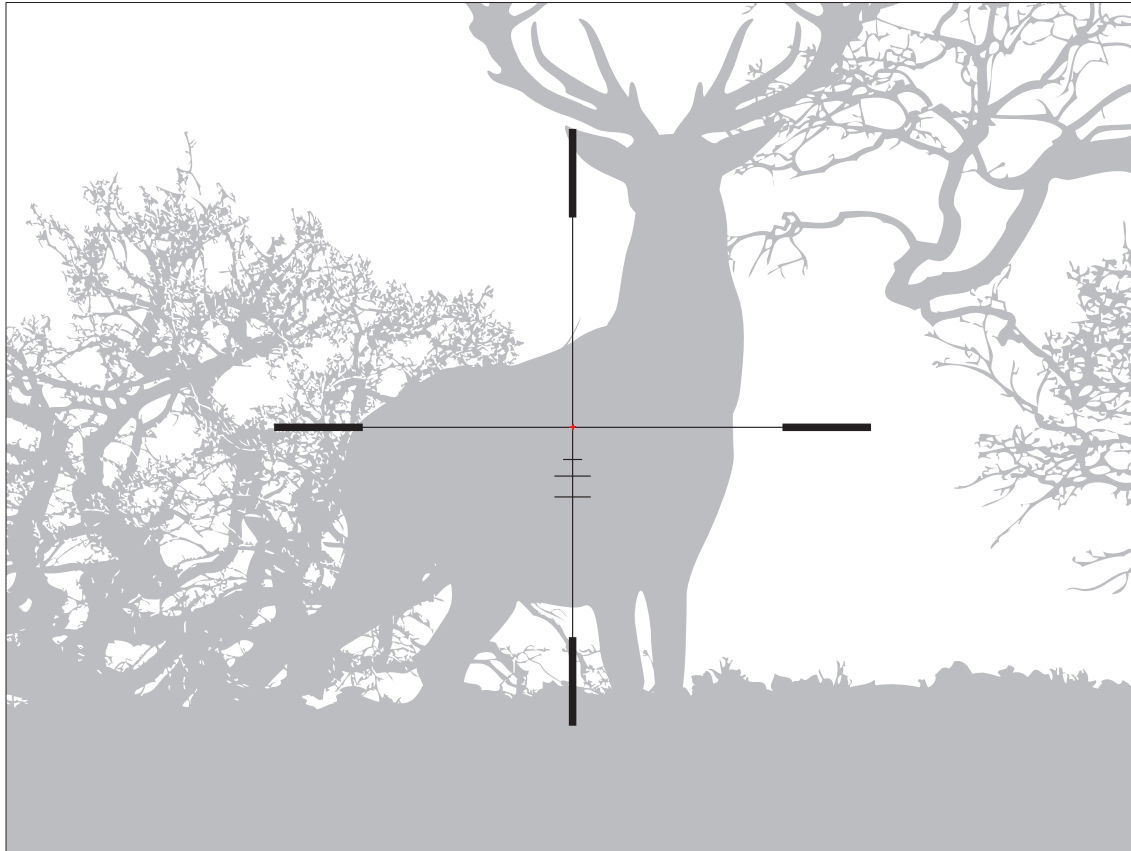

Reticle parameters (apply to all magnifications)

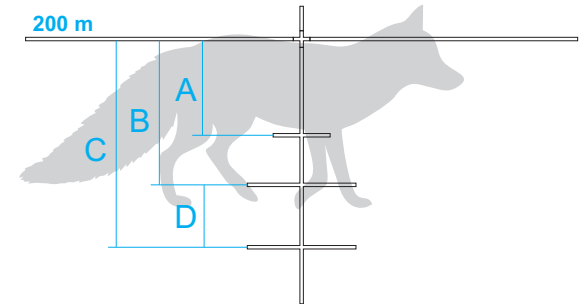

	200 m	300 m
Section A	15 cm (fox body)	23 cm (roe deer body)
Section B	23 cm (roe deer body)	35 cm (wild boar body)
Section C	35 cm (wild boar body)	50 cm (deer body)
Section D	—	15 cm (fox body)

Digital Night Vision Riflescopes
DIGISIGHT
ULTRA N400th

SCALABLE

M56Fi

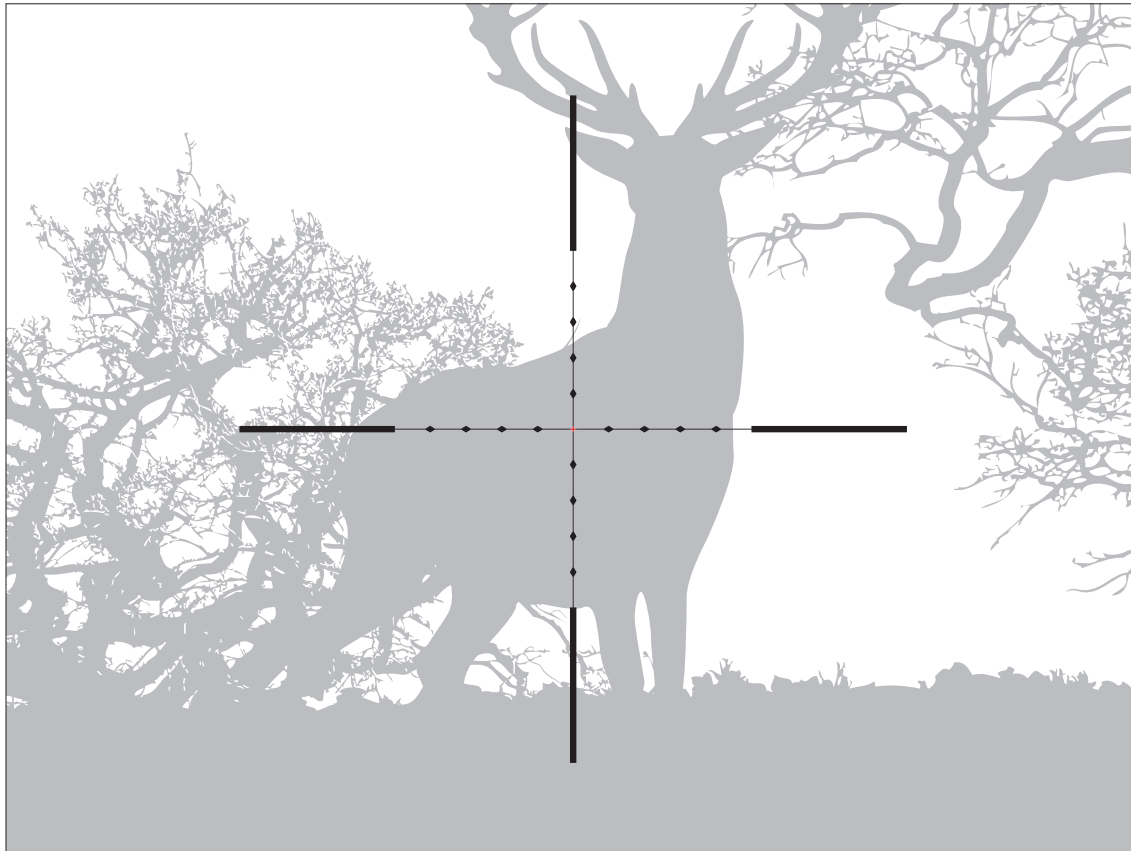

Reticle parameters (apply to all magnifications)

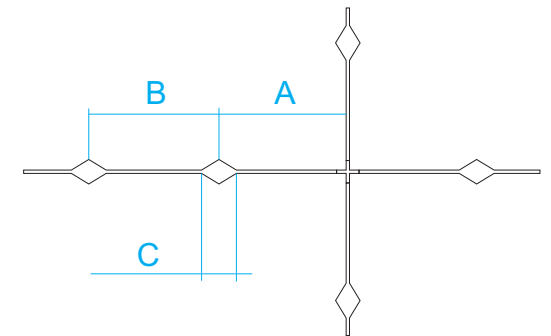

	MOA	cm @ 100 m
Section A	3.5	10 (1 mil)
Section B	3.5	10 (1 mil)
Section C	0.86	2.5 (0.25 mil)

SCALABLE

M57Fi

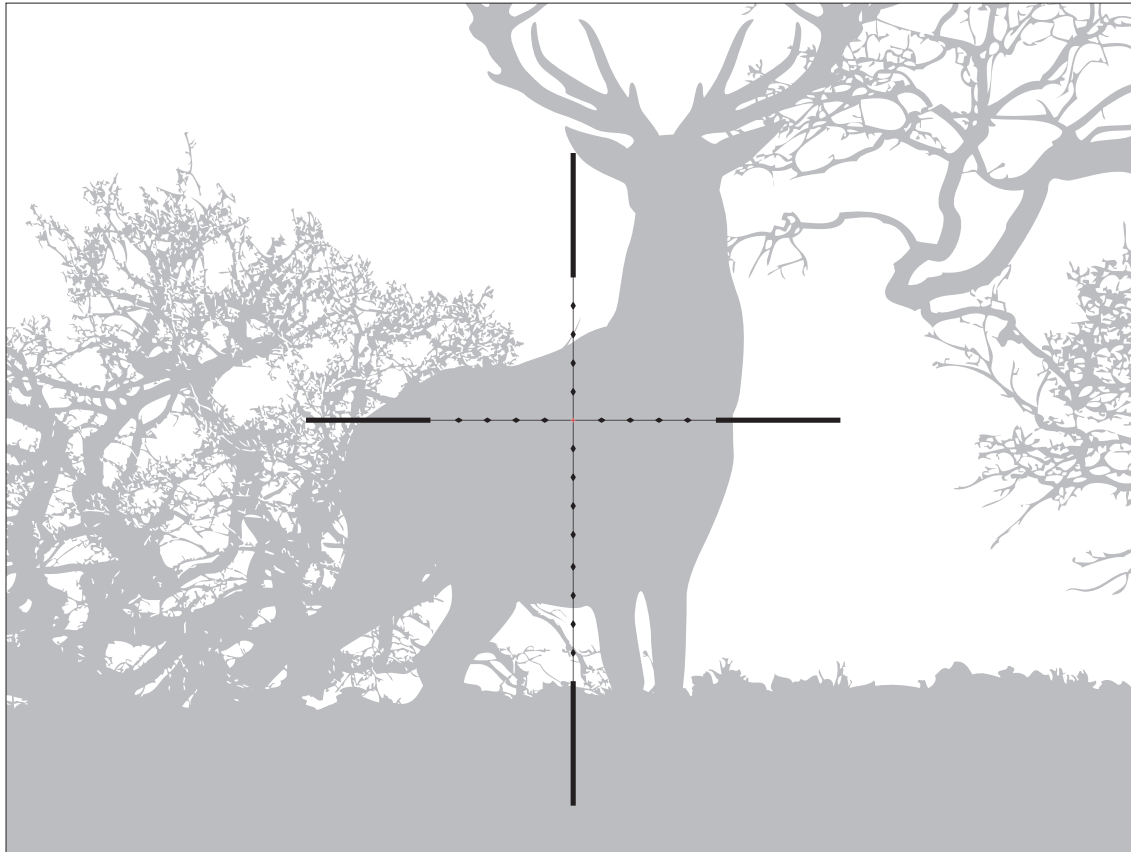

Reticle parameters (apply to all magnifications)

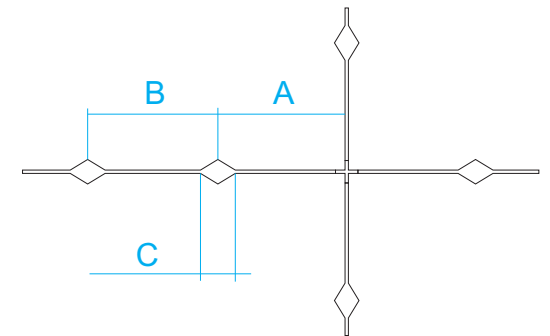

	MOA	cm @ 100 m
Section A	3.5	10 (1 mil)
Section B	3.5	10 (1 mil)
Section C	0.86	2.5 (0.25 mil)

