

VIPER⁵⁰ Next *by* **NITEHOG™**

KURZANLEITUNG
QUICK GUIDE

DE
EN



NITEHOG™

VORSATZGERÄT

VIPER ⁵⁰ **Next**
by NITEHOG™

KURZANLEITUNG

INHALTSVERZEICHNIS

1. Produktüberblick.....	6
2. Funktionen.....	8
3. Menü.....	10
3.1 Darstellung.....	10
3.1.1 Bild.....	11
3.1.2 Eigenschaften.....	17
3.1.3 Einstellungen.....	20
3.1.4 Modus.....	22

DE

1 PRODUKTÜBERBLICK

INFO



Alle in dieser Bedienungsanleitung verwendeten Bilder dienen nur zu Illustrationszwecken. Das tatsächliche Produkt kann aufgrund von Produktverbesserungen abweichen.

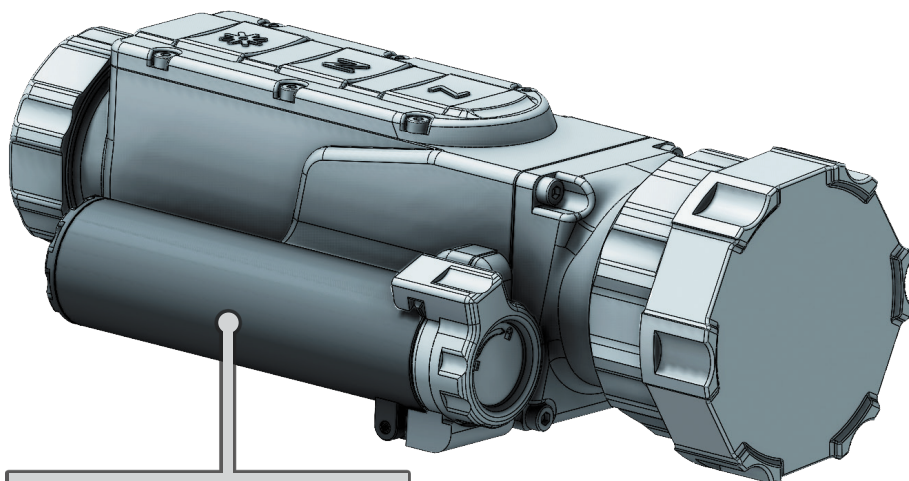

BATTERIEFACH

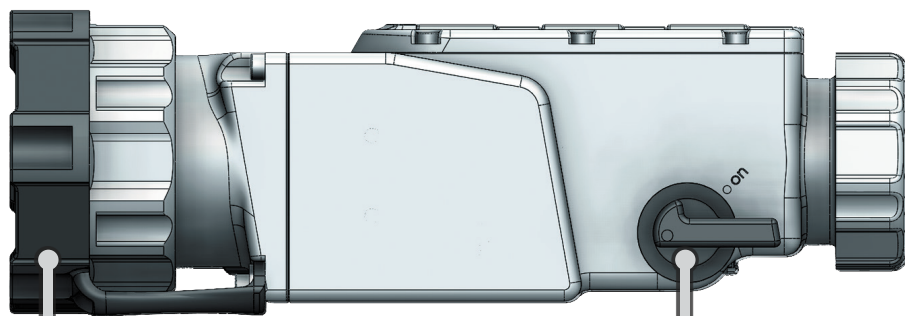

OBJEKTIVSCHUTZDECKEL

EIN / AUS SCHALTER

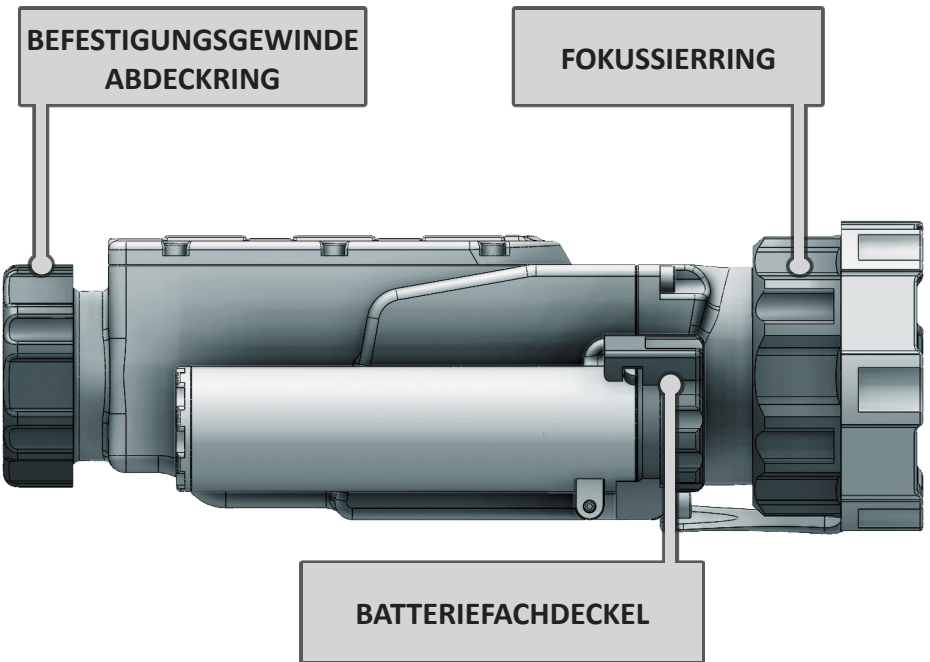
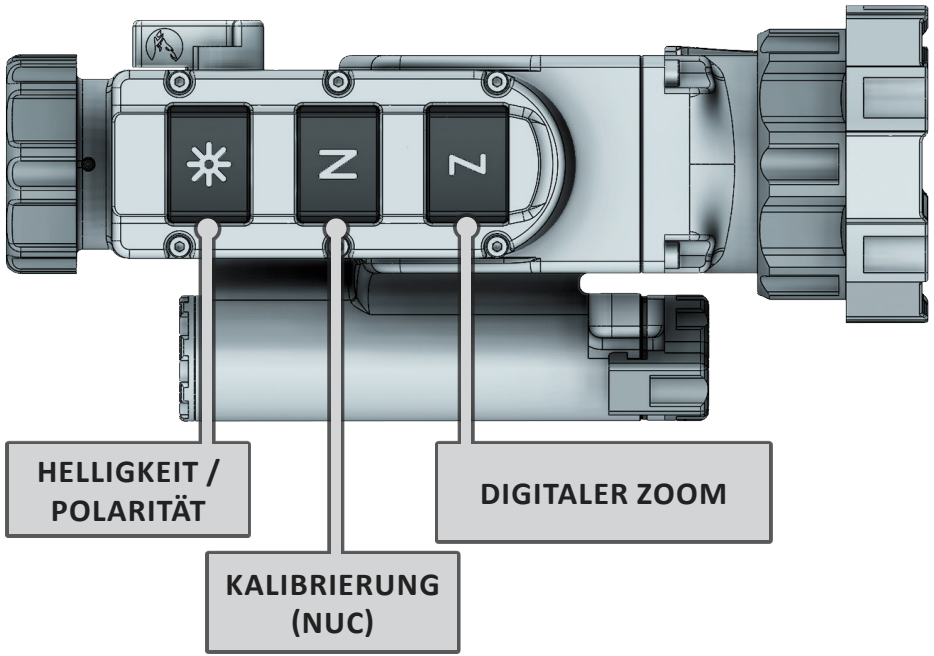

2



FUNKTIONEN

WICHTIG!



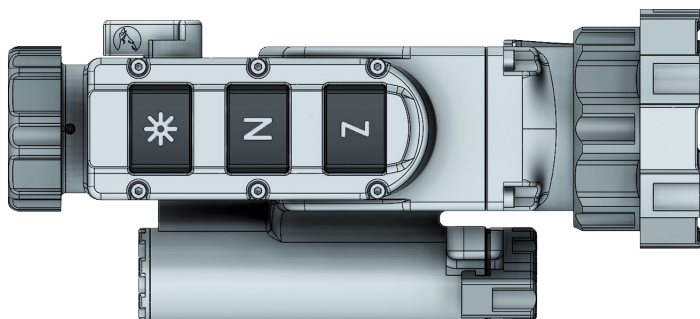

Die Hauptfunktionen werden durch die Knöpfe **Z**, **N** und  ausgeführt.



TASTEN	KURZ DRÜCKEN	LANGE DRÜCKEN
	<i>Digitaler Zoom / im Beobachtungsmodus</i>	<i>Beim Einschalten des Gerätes wird die SRF-Funktion aktiviert.</i>
	<i>Infobox / im Vorsatzmodus</i>	
	<i>NUC-Aktivierung</i>	<i>Aktivieren der Auto-Isotherm-Palette. Beim Einschalten des Gerätes, wird das Piktogramm Auto-Isotherm aktiviert.</i>
	<i>Wechselt zwischen vier Stufen der Display-Luminanz</i>	<i>Außerhalb der Menüfunktion: Kehrt das Bild zwischen Weiß- und Schwarzmodus um</i>
		<i>In der Menüfunktion: Schnellmenü verlassen</i>
	<i>Wechselt zwischen Vorsatz- und Beobachtungsmodus</i>	
	<i>Aktivieren des Gerätemenüs.</i>	





WICHTIG!



Die Knöpfe ,  und  können mehrere Funktionen haben.

DE

Neben der Haupt- und Nebenfunktionen dienen die Menükнопfe auch zum Aufrufen des Menüs und zur Funktionsauswahl.

TASTEN	KURZ DRÜCKEN
 + 	<i>Aktiviert das Menü</i>
	<i>Bewegt den Cursor nach oben</i>
	<i>Bewegt den Cursor nach unten</i>
	<i>Funktion auswählen</i>

3.1 Darstellung

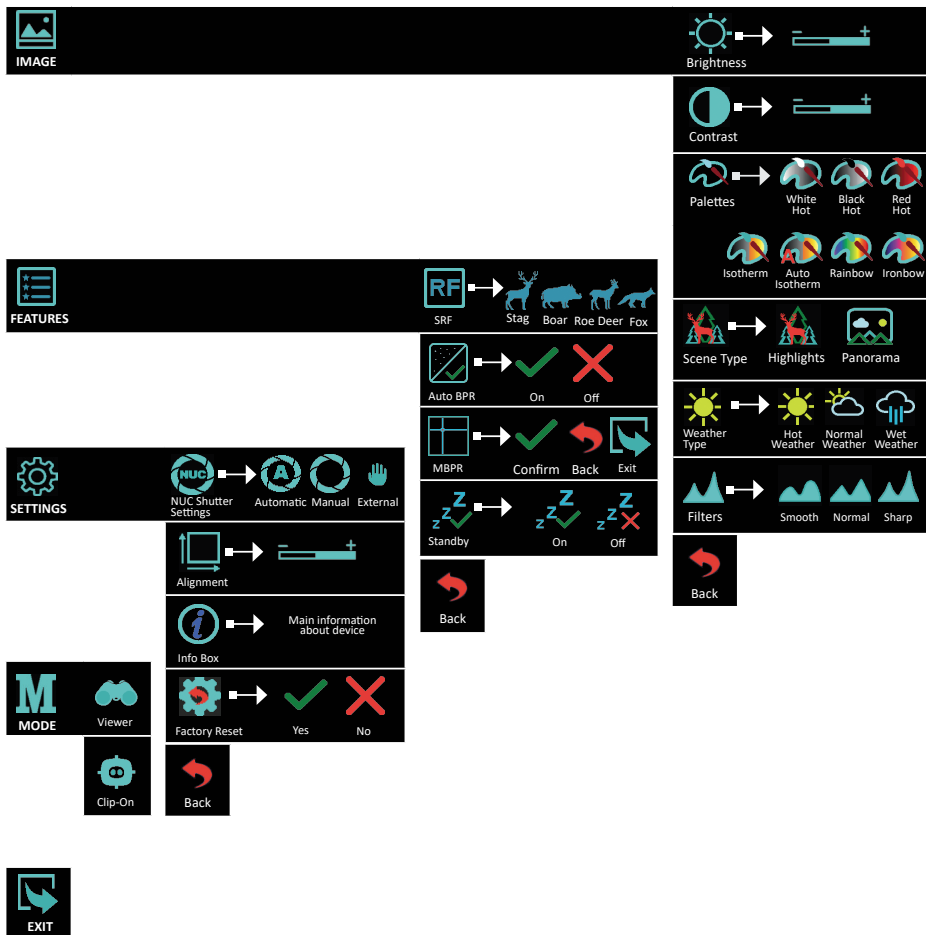

3.1.1 Bild

3.1.1.1 Helligkeit

Die Auswahl der **Helligkeit** gibt Ihnen die Möglichkeit, Ihr eigenes, benutzerdefiniertes Niveau der Bildhelligkeit einzustellen.

Die Helligkeit ist nicht abhängig von der Helligkeitseinstellung, die mit der Taste  vorgenommen wird!



3.1.1.2 Kontrast

Die Auswahl des **Kontrasts** gibt Ihnen die Möglichkeit, Ihren eigenen benutzerdefinierten Bildkontrast einzustellen (Verstärkung).

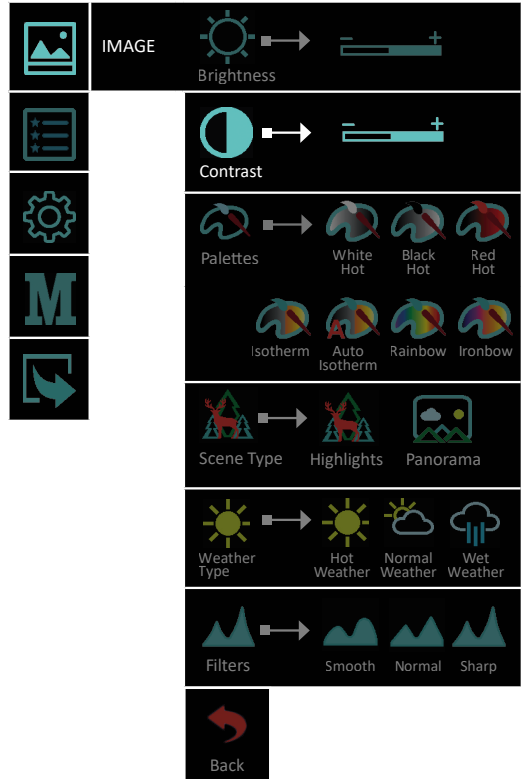

3.1.1.3 Palette

Eine Vielzahl von Farbpaletten können verwendet werden:

-  **White Hot (Weiß warm)**
-  **Black Hot (Schwarz warm)**
-  **Red Hot (Rot warm)**
-  **Isotherm**
-  **Auto Isotherm**
-  **Rainbow (Regenbogen)**
-  **Ironbow (Eisenbogen)**

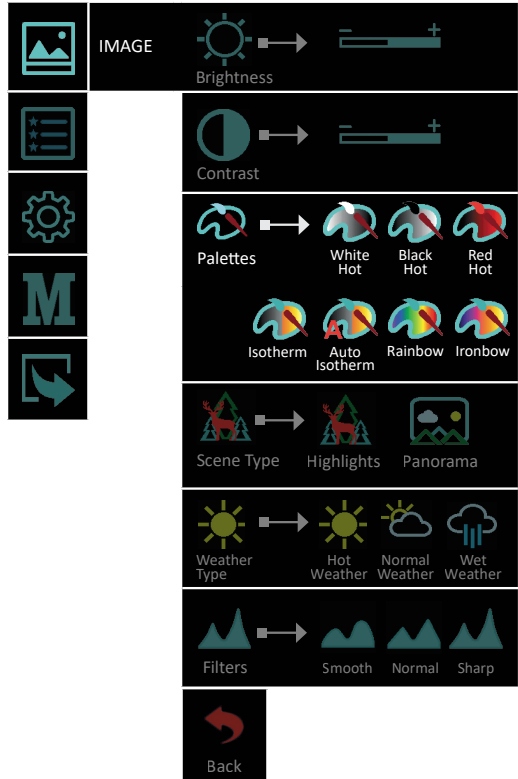

DE

Die Funktion **Auto Isotherm** kann durch langes Drücken der **N**-Taste aktiviert werden.

Um sie zu deaktivieren, drücken Sie lange auf die  Taste, um in den **WH/BH**-Modus zu wechseln.

3.1.1.4 Szenentyp



Highlights - Diese Bildkontrastierung ist für die Erkennung und Beobachtung geeignet.



Panorama - Das Bild ist bei Änderungen in der Dynamik der Szene sehr stabil. Geeignet für die Beobachtung von Panoramaszenen.

The screenshot shows a vertical menu of image processing options. On the left side, there are four icons: a landscape with a red deer, a list with three items, a gear, and a large letter 'M'. The main menu items are:

- IMAGE**: A sun icon with a slider bar, labeled "Brightness".
- Contrast**: A circle with a vertical line and a slider bar.
- Palettes**: A slider bar followed by four color palette icons labeled "White Hot", "Black Hot", "Red Hot", and "Isotherm".
- Scene Type**: A slider bar followed by three icons labeled "Highlights" (a red deer) and "Panorama" (a landscape with a red deer).
- Weather Type**: A slider bar followed by four weather icons labeled "Hot Weather", "Normal Weather", and "Wet Weather".
- Filters**: A slider bar followed by three filter icons labeled "Smooth", "Normal", and "Sharp".
- Back**: A red curved arrow icon.

3.1.1.5 Wassertyp

Sie können zwischen 3 Filtern wählen:

 **Hot Weather (Warmes Wetter)**

 **Normal Weather (Normales Wetter)**

 **Wet Weather (Nasses Wetter)**

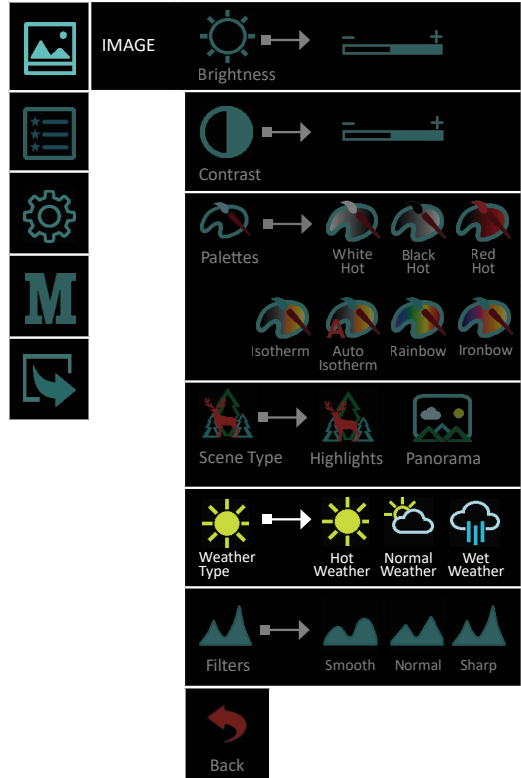

The screenshot shows a vertical menu of editing options. On the left, there are icons for 'IMAGE', a list, a gear, a large 'M', and a refresh arrow. The main menu items are: 'IMAGE' (with a sun icon and a slider), 'Brightness' (with a sun icon and a slider), 'Contrast' (with a circle icon and a slider), 'Palettes' (with four color palette icons: White Hot, Black Hot, Red Hot, and Isotherm), 'Isotherm' (with an Isotherm icon), 'Auto Isotherm' (with an Auto Isotherm icon), 'Rainbow' (with a Rainbow icon), 'Ironbow' (with an Ironbow icon), 'Scene Type' (with a deer icon and a slider), 'Highlights' (with a deer icon and a slider), 'Panorama' (with a landscape icon), 'Weather Type' (with four weather icons: Hot Weather, Normal Weather, and Wet Weather), 'Filters' (with three filter icons: Smooth, Normal, and Sharp), and 'Back' (with a red arrow icon).

3.1.1.6 Filter

Sie können zwischen 3 Stufen der Bildschärfe wählen:

 **Smooth (Weich)**

 **Normal**

 **Sharp (Scharf)**

Das Piktogramm im Hauptmenü zeigt die aktive Benutzerauswahl an.

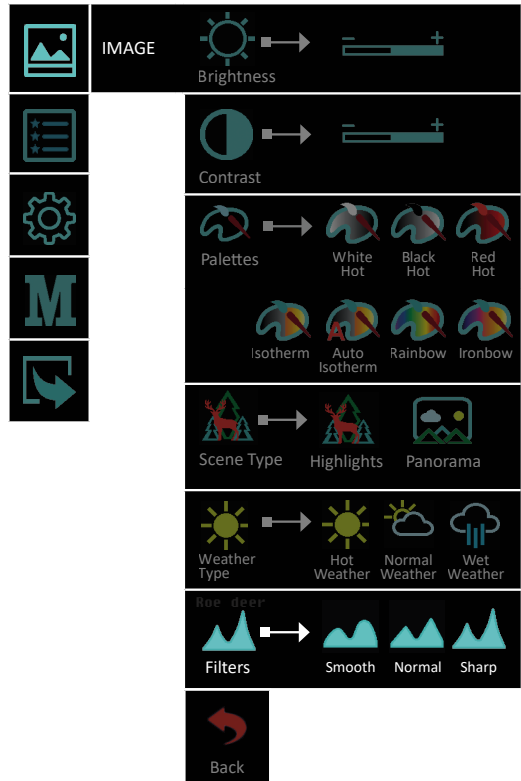

3.1.2 Eigenschaften

3.1.2.1 SRF

Aktivieren Sie die **Funktion Stadiumetrischer Entfernungsmesser (SRF)** durch langes Drücken der **Z**-Taste oder durch Auswahl aus dem Funktionsmenü. Sie sehen auf dem Display: Messbalken, Symbole von vier Referenzobjekten und die jeweiligen Entfernungen zu diesen Objekten. Positionieren Sie die untere feste Leiste unter dem avisierten Objekt.

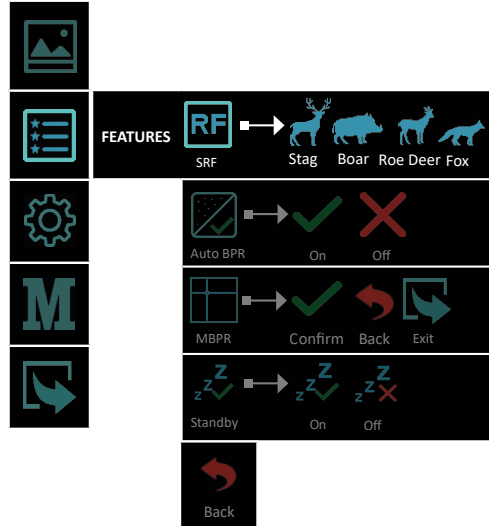

Es gibt vier vordefinierte Silhouetten für die Referenzobjekte:



Stag (Hirsch) - 1.40m



Boar (Wildschwein) - 0.85 m



Roe deer (Reh) - 0.70m



Fox (Fuchs) - 0.40m

3.1.2.2 Auto BPR

Die **AUTO BPR**-Funktion bietet die Möglichkeit, fehlerhafte Pixel, die auf dem Mikrobolometer erschienen sind, automatisch zu finden und zu löschen.

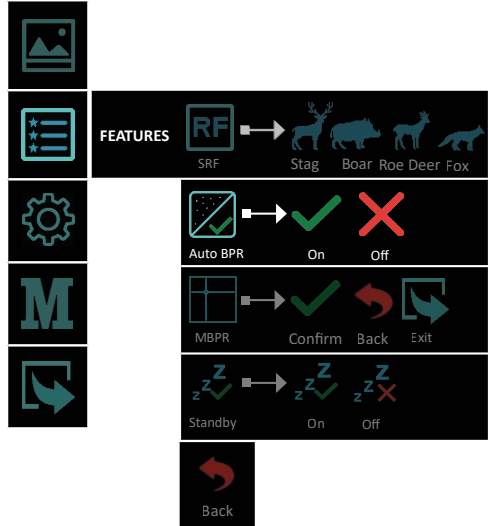

3.1.2.3 MBPR

Das Gerät bietet eine Funktion zur manuellen Korrektur fehlerhafter Pixel.

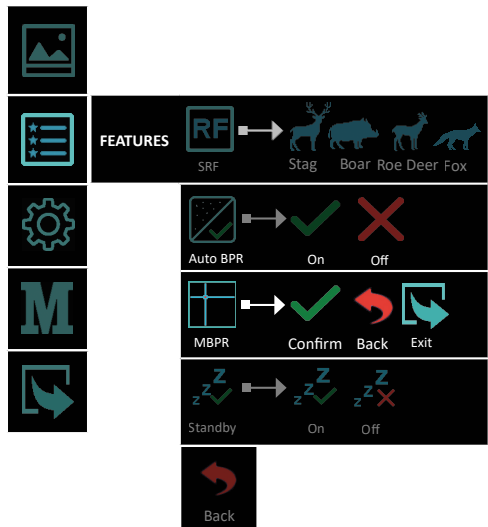

3.1.2.4 Stand-by

In diesem Zustand geht das Gerät in einen stromsparenden Zustand über und schaltet das Display über und schaltet das Display.

DE

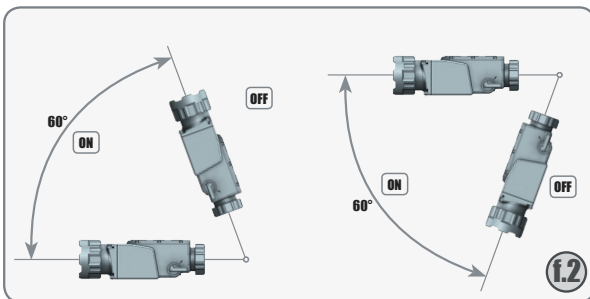
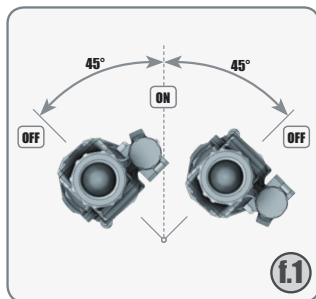
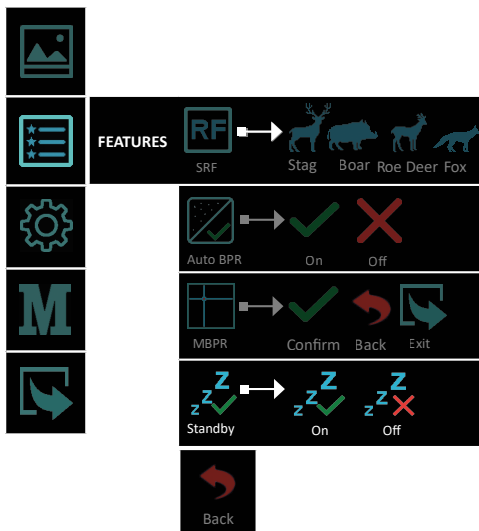

3.1.3 Einstellungen

3.1.3.1 NUC Kalibrierung

- **Automodus:** Die Kalibrierung erfolgt automatisch in regelmäßigen Intervallen mit Hilfe eines Verschlussmechanismus im Automodus!
- **Manueller Modus:** Die Kalibrierung wird vom Benutzer durch Drücken der Taste **N** länger als 2 Sekunden in gewünschten Intervallen durchgeführt. Es ist nicht erforderlich, dass der Benutzer die Linse mit einer äußeren Barriere abdeckt.
- **Externer Modus:** Die Kalibrierung wird vom Benutzer durch Drücken der Taste **N** in gewünschten Intervallen durchgeführt. Dabei wird mit Hilfe der Hand oder der Schutzkappe eine externe Linsenbarriere erzeugt. Der Benutzer muss den Energieeintritt durch die Linse zum Sensor des Geräts unterbrechen. Eine Kalibrierung ohne diese Wärmebarriere erzeugt einen Effekt der "Geisterbilder".

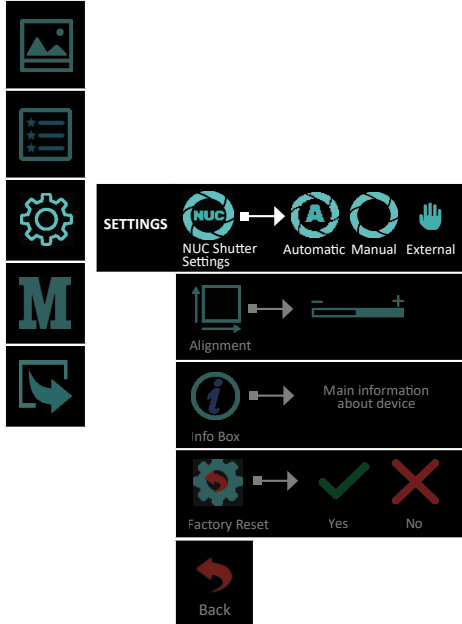

3.1.3.2 Ausrichtung

Mit der **Ausrichtungsfunktion** können Sie die optischen Achsen der Primäroptik und des Vorsatzgerätes präzise ausrichten.

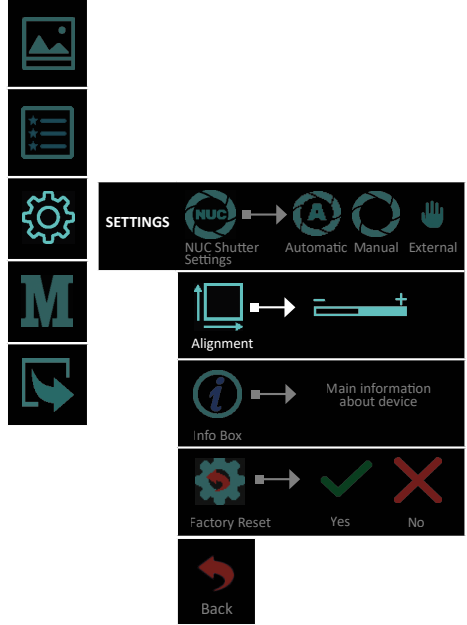

3.1.3.3 Info Box

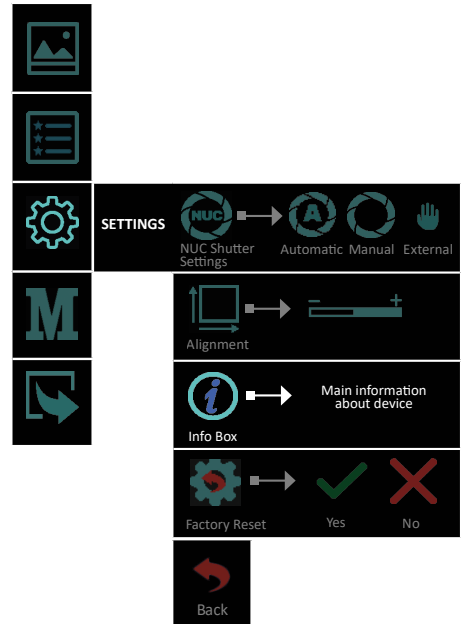
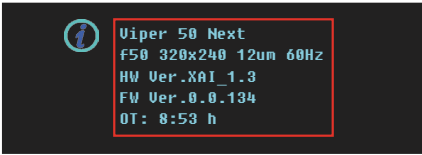

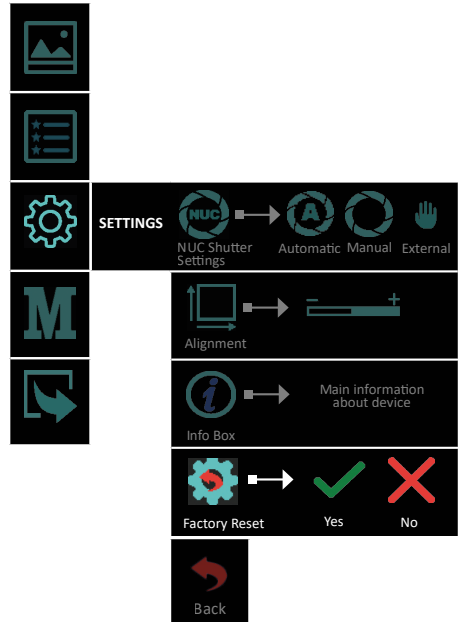

3.1.3.4 Werkreset

Durch Auswahl und Bestätigung dieser Funktion werden alle Werkeinstellungen des Geräts wiederhergestellt.



3.1.4 Modus

Um die VIPER als Vorsatzgerät zu verwenden, wählen Sie **Modus** >  **Clip-on** im Menü aus.

Schnellfunktion zum Umschalten zwischen Beobachtungs- und Vorsatzmodus: Halten Sie die Taste  und die Taste  gleichzeitig gedrückt.

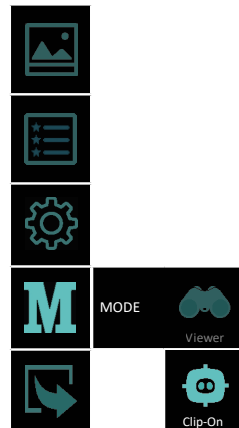

THERMAL IMAGING MULTIFUNCTIONAL DEVICE

VIPER ⁵⁰ **Next**
by **NITEHO®**™

QUICK GUIDE

1. Device overview	28
2. Controls	30
3. Menu	32
3.1 Appearance	32
3.1.1 Image	33
3.1.2 Features	39
3.1.3 Settings	42
3.1.4 Mode	44

1

DEVICE OVERVIEW

NOTE



All images used in this instruction manual are for illustrative purpose only. Actual product may vary due to product enhancement.

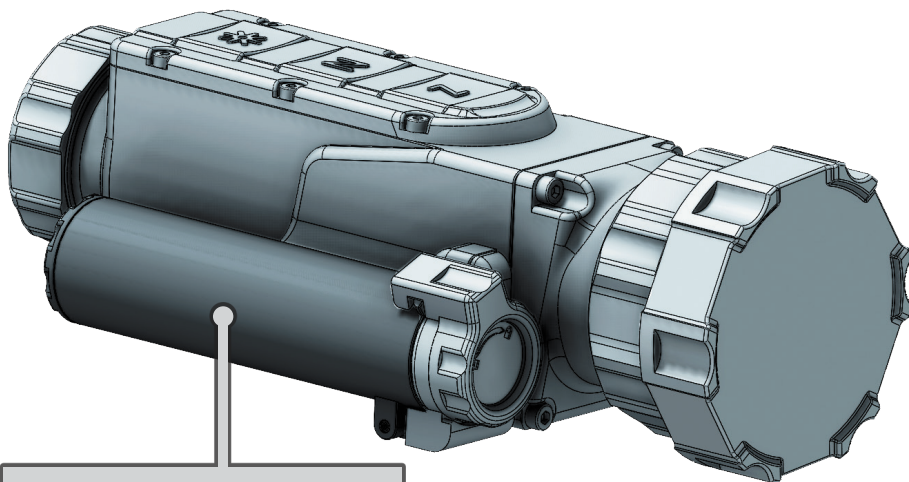

BATTERY COMPARTMENT

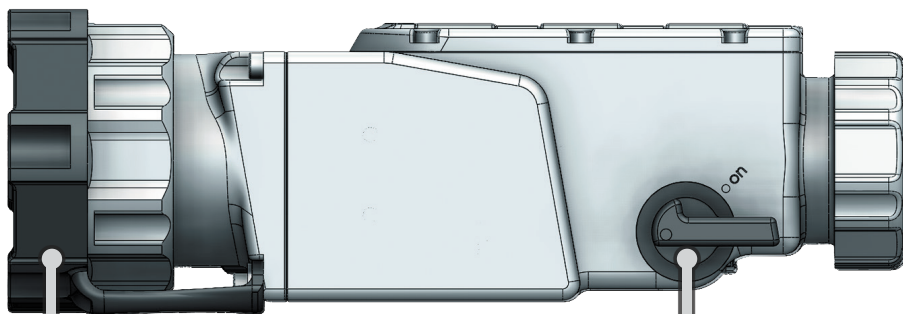

PROTECTIVE LENS COVER

ON/OFF SWITCH

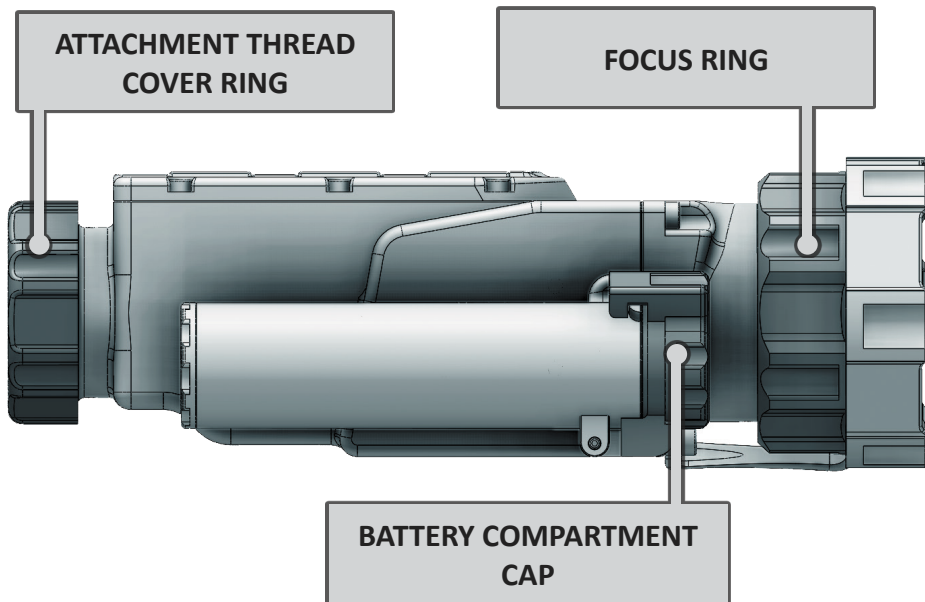
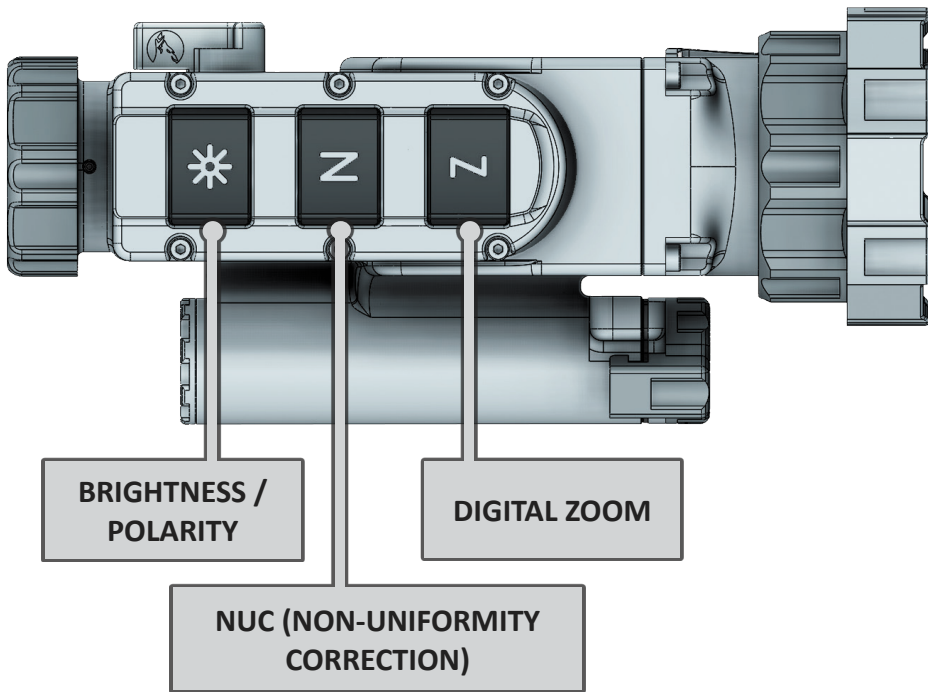

2





CONTROLS

ATTENTION!

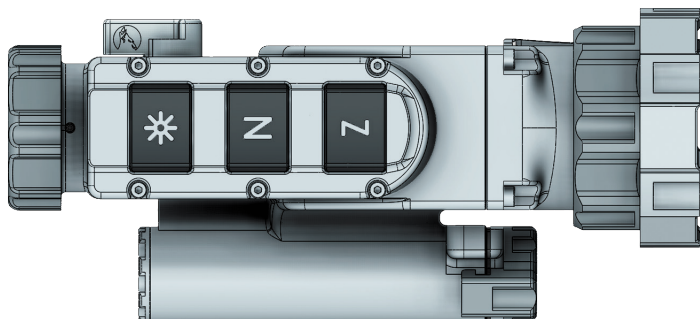

The main operations are performed through the buttons **Z**, **N** and .



BUTTONS	SHORT PRESS	LONG PRESS
	Digital zoom/in observation mode	When the device is switched on, the SRF function is activated.
	Infobox/in Clip-on mode	
	NUC activating	Activating the Auto Isotherm Palette. When the device is switched on, the Auto Isotherm pictogram is activated
	Changes between four values of the display luminance	When you are not in the Menu function: Inverts the image between white and black mode
		In the menu function: quick Menu exit
	Switch between Clip-on and observation mode	
	Activating the Menu of the device.	





ATTENTION!



The buttons ,  and  are dual purpose buttons!

Besides the main and secondary functions, they also serve for entering and navigation through the menu.

EN

BUTTONS	SHORT PRESS
	<i>Activates the menu</i>
	<i>Moves the cursor up</i>
	<i>Moves the cursor down</i>
	<i>Function select</i>

3.1 Appearance

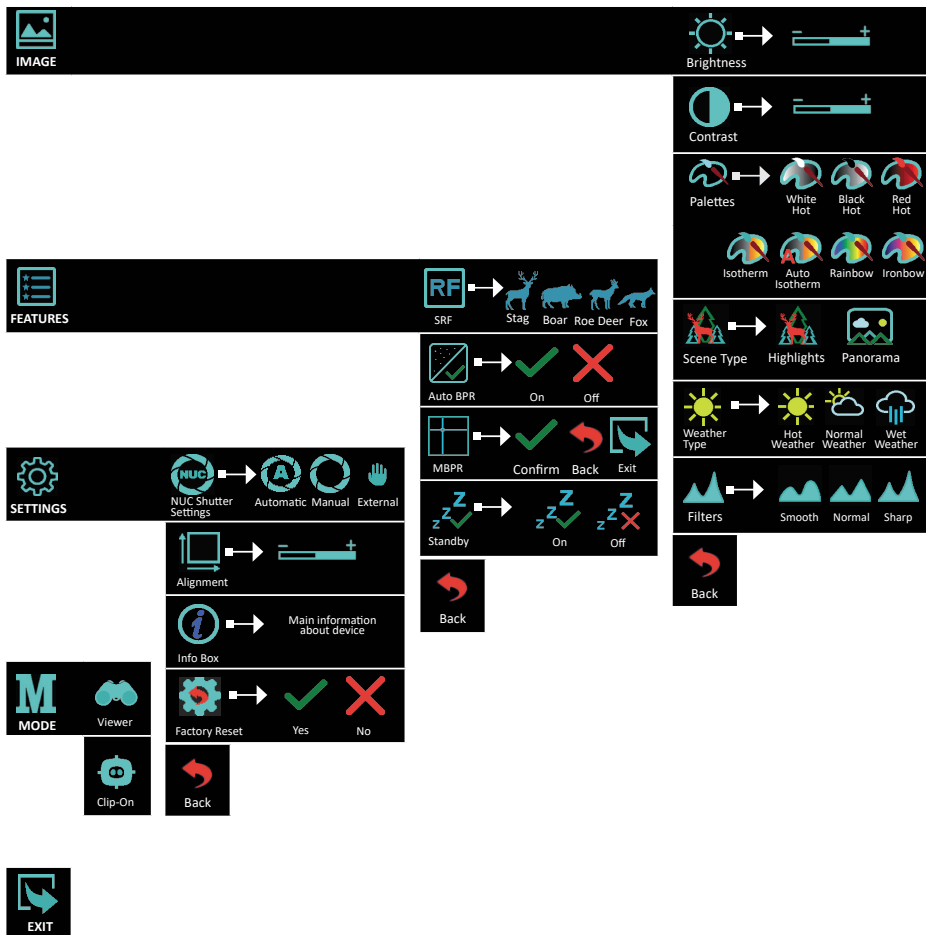

3.1.1 Image

3.1.1.1 Brightness

Selecting **Brightness** gives the opportunity to set your own user-defined level of image brightness.



EN





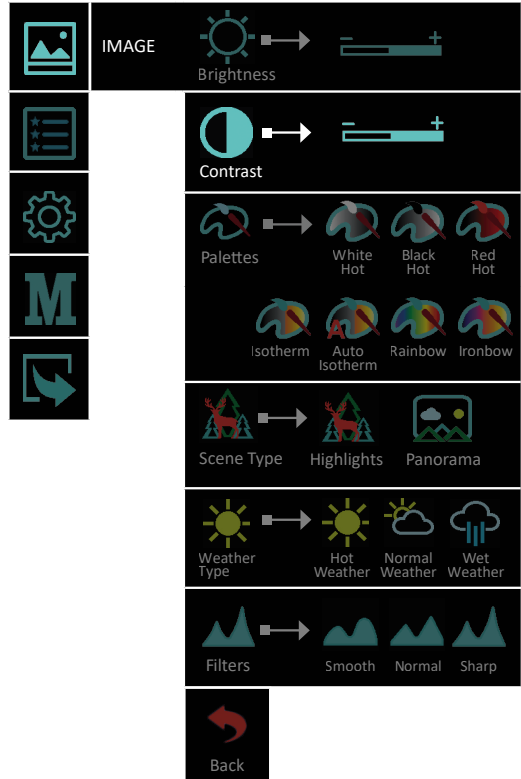

3.1.1.2 Contrast

Selecting **Contrast** gives the opportunity to set your own user-defined level of image contrast (Gain).



3.1.1.3 Palettes

A variety of color palettes can be used: **White Hot**, **Black Hot**, **Red Hot**, **Isotherm**, **Auto Isotherm**, **Rainbow** and **Ironbow**.

-  **White Hot**
-  **Black Hot**
-  **Red Hot**
-  **Isotherm**
-  **Auto Isotherm**
-  **Rainbow**
-  **Ironbow**

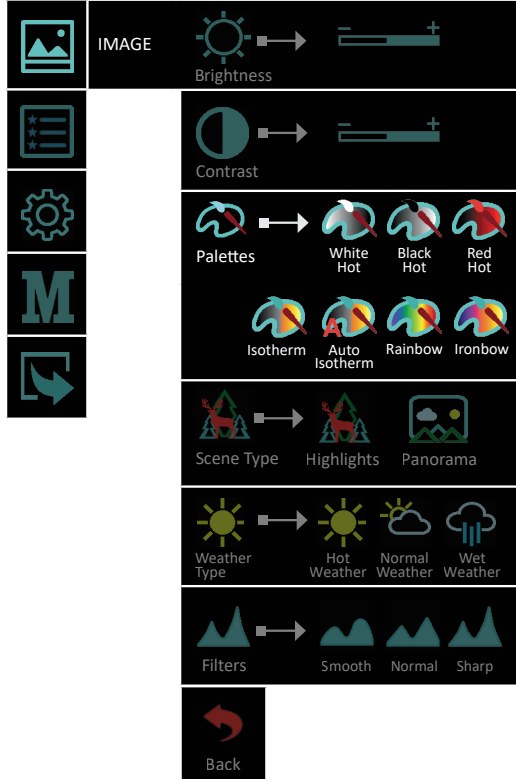

The screenshot shows the camera's image processing menu. The menu is a vertical stack of options:

- IMAGE** (with image icon)
- Brightness** (with sun icon and slider)
- Contrast** (with moon icon and slider)
- Palettes** (with palette icon and sub-options: White Hot, Black Hot, Red Hot)
- Isotherm** (with palette icon and sub-options: Isotherm, Auto Isotherm, Rainbow, Ironbow)
- Scene Type** (with deer icon and sub-options: Highlights, Panorama)
- Weather Type** (with sun icon and sub-options: Hot Weather, Normal Weather, Wet Weather)
- Filters** (with mountain icon and sub-options: Smooth, Normal, Sharp)
- Back** (with red arrow icon)

The **Auto Isotherm** function can be activated with a long press of the **N** button.

To deactivate it, long press the  button to enter **WH/BH** mode.

3.1.1.4 Scene Type

 **Highlights** - this type of image contrasting is suitable for detection and observation.

 **Panorama** – The picture is very stable during changes in the dynamics of the scene. Suitable for observing panoramic scenes.

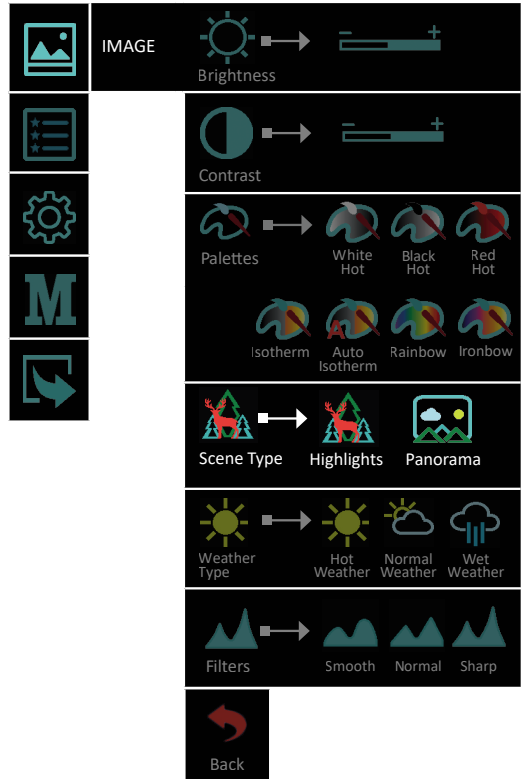

The screenshot displays a vertical menu on the left with icons for: Image, List, Settings, 'M' (Matrix), and a curved arrow. The main interface is a dark panel with the following sections:

- IMAGE**: Brightness slider.
- Contrast**: Contrast slider.
- Palettes**: Four color palette options: White Hot, Black Hot, Red Hot, and Isotherm.
- Filters**: Four filter options: Isotherm, Auto Isotherm, Rainbow, and Ironbow.
- Scene Type**: Three scene type options: Scene Type, Highlights, and Panorama.
- Weather Type**: Four weather type options: Hot Weather, Normal Weather, Wet Weather, and another Hot Weather icon.
- Filters**: Three filter options: Smooth, Normal, and Sharp.
- Back**: A red curved arrow button.













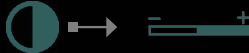













3.1.1.5 Weather Type

You may choose between 3 filters:

 **Hot Weather**

 **Normal Weather**

 **Wet Weather**

	IMAGE		Brightness
			Contrast
		   	Palettes White Hot Black Hot Red Hot
		   	Isotherm Auto Isotherm Rainbow Ironbow
		  	Scene Type Highlights Panorama
		   	Weather Type Hot Weather Normal Weather Wet Weather
		   	Filters Smooth Normal Sharp
			Back

EN

3.1.1.6 Filter

For a more detailed image and clear edges, you can switch between 3 levels of image sharpness:

 Smooth

 Normal

 Sharp

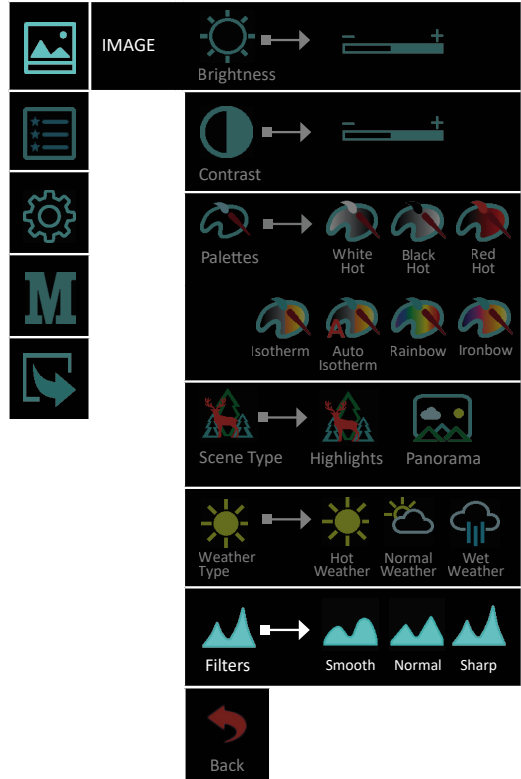

3.1.2 Features

3.1.2.1 SRF

Activate the **Stadiametric Range Finder (SRF)** function with long presses of the **Z** button or by selecting it from the **Features** menu.

You will see on the display: measurement bars, icons of four reference objects and respective distances for these objects.

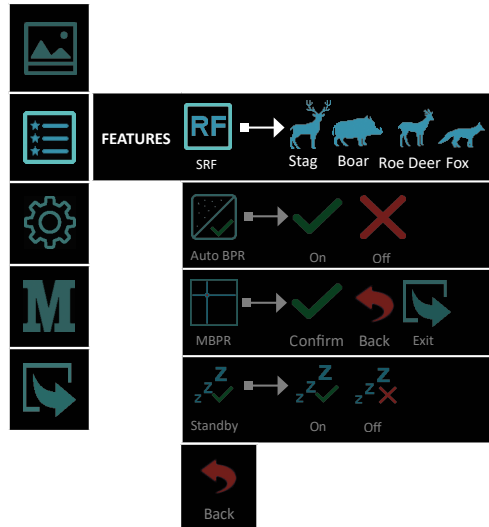

There are four predefined silhouettes for the reference objects:

 **Stag** (1.40m)

 **Boar** (0.85 m)

 **Roe deer** (0.70m)

 **Fox** (0.40m)

3.1.2.2 Auto BPR

The **AUTO BPR** functionality gives the opportunity to automatically correct and clear bad pixels that have appeared on the microbolometer.

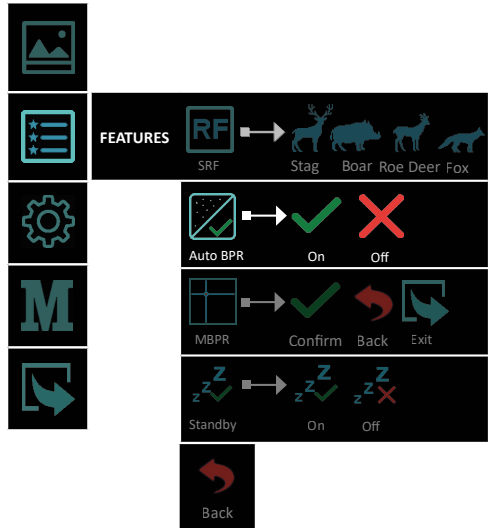

3.1.2.3 MBPR

The device offers a function for manual correction of defective pixels.

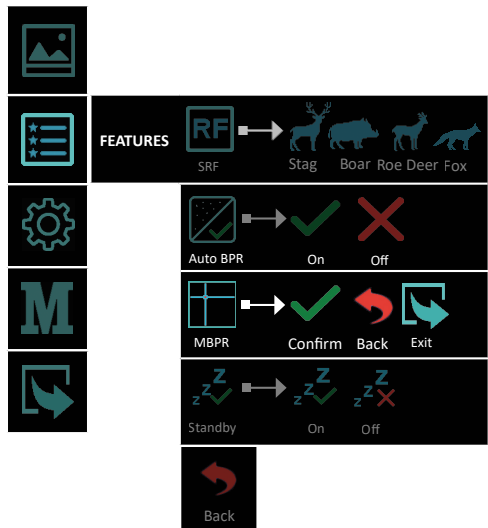

3.1.2.4 Standby

In this condition, the device passes into a low-power consumption state and switches off the display.

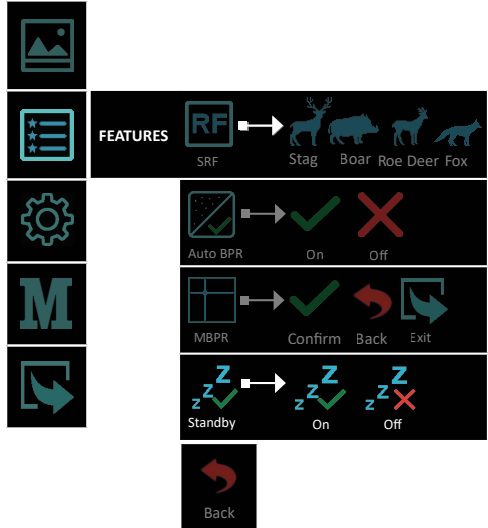

EN

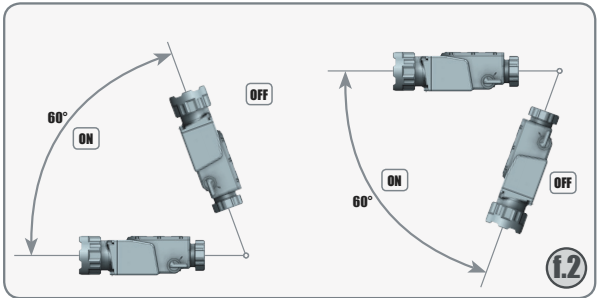
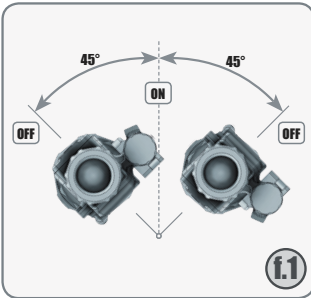

3.1.3 Settings

3.1.3.1 NUC Shutter Settings

- **Automatic mode** - The calibration is performed automatically at regular intervals and with a shutter mechanism located in the device.
- **Manual mode** - The calibration is performed by the user, by pressing and holding the **N** button for more than 2 seconds, at desired intervals, with a shutter mechanism located in the device. It is not necessary for the user to cover the lens with an external barrier.
- **External mode** - The calibration is performed by the user, by pressing the **N** button, at desired intervals, with an external lens barrier, which can be a hand or the protective cap of the lens. The user must eliminate the entry of energy through the lens to the sensor of the device. Calibration without closing the lens will create a “ghost” effect in the image.

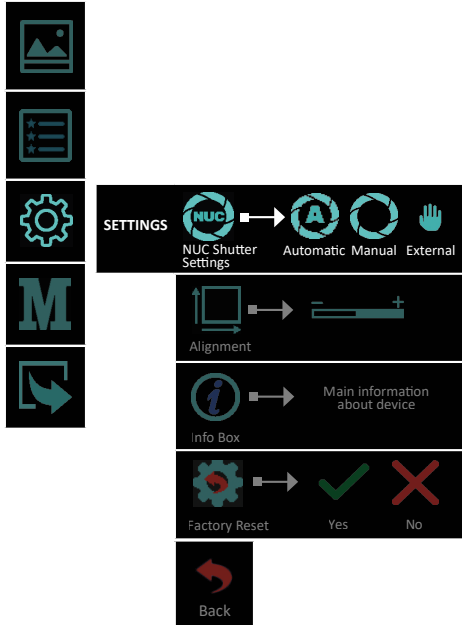

3.1.3.2 Alignment

With Alignment function, you can precisely align the optical axis of the day sight and the clip-on attachment.

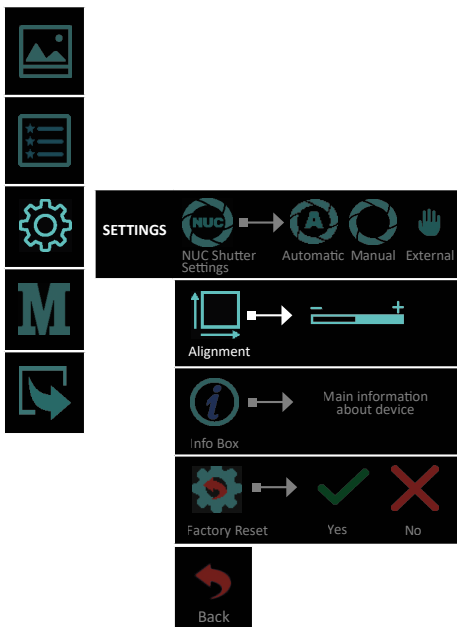

3.1.3.3 Info Box

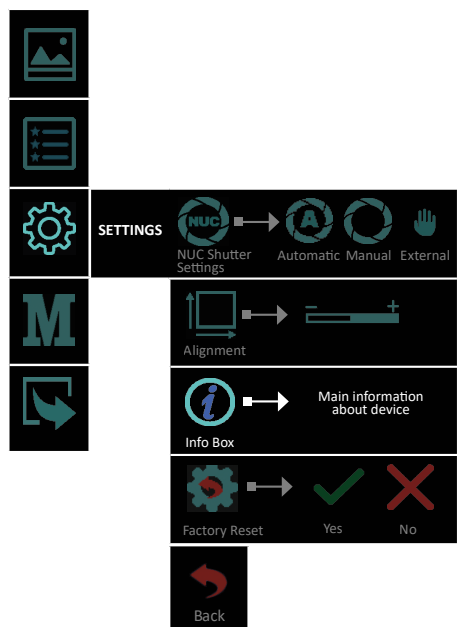
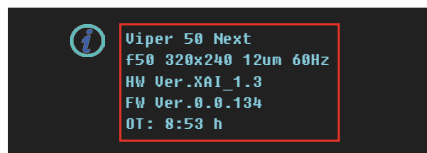

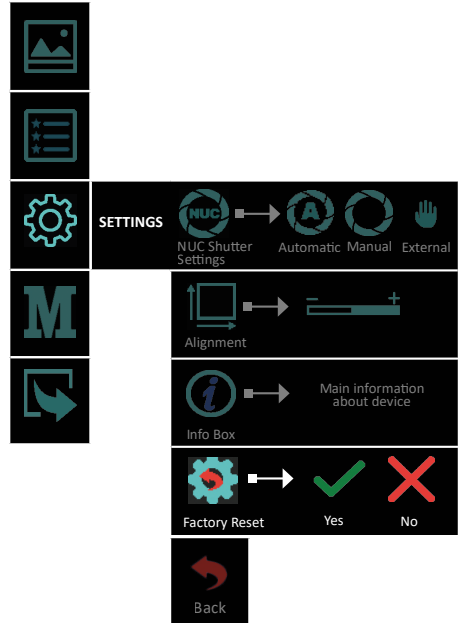

3.1.3.4 Factory Reset

By selecting and confirming this feature all factory settings of the device are restored.



3.1.4 Mode

To use Viper 50 Next as a clip-on device select **Mode>Clip-On**  from the menu.

Quick function for switching between observation and clip-on mode: hold down the button  and the  button simultaneously.

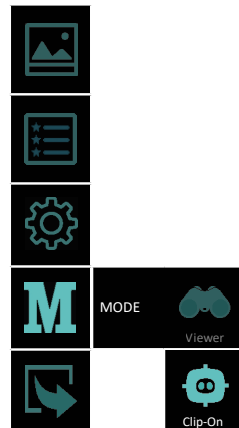

ANMERKUNGEN

NOTES

A series of horizontal dotted lines for writing notes.

Website:

<https://nitehog.com/>

Youtube:

Nitehog Europe GmbH

Facebook:

<https://www.facebook.com/NitehogEuropeGmbH>

Instagram:

<https://www.instagram.com/nitehog/>

Contacts:

**Pistoriusstrasse 6A, 13086 Berlin, Germany
info@nitehog.eu**

+49 (0) 30 / 9606 670 220