

# **Tube Series Operating Manual**

**V1.0**

**InfiRay Technologies Co., Ltd.**

## Specifications

Model	TD50L
Resolution, pixels	1440×1080
Frame Rate, Hz	50
Objective Lens, mm	50 (F1.2)
Field of View, °	6.6×4.9
Magnification, ×	4.0~16.0
Smooth zoom	Support
Eye Relief, mm	70
Diopter Adjustment, D	-4~+4
Type	LCOS
Resolution, pixels	1280×960
Video record resolution, pixels	1440×1080
Capture resolution, pixels	1440×1080
Detection range, m	600
Battery	Built-in 6600mAh and a replaceable 1500mAh
Max. Operating Time (at temp.=22°C), h*	>13
External power supply	5V (Type C USB)
Diameter of the riflescope body to assemble the mounting rings, mm	30
Max. Recoil Power on Rifled Weapon, g/s <sup>2</sup>	1000
Degree of protection, IP code	IP67
Amount of built-in memory, GB	16
Weight (without replaceable battery), g	<1000
Dimension, mm	395×85×75
APP	Support
Smart range finder	Support
IR illuminator,nm	850/940
Max Power of IR illuminator , w	2.2

\*Actual operation time depends on the density of Wi-Fi use and video recording functions;

\*The product package does not contain the IR illuminator. Please select 850nm/940nm IR illuminator according to your own needs.

Improvements may be made to the design and software of this product to enhance its features without prior notice to the customer;

You can download this Manual at our official website: [www.xinfrared.com](http://www.xinfrared.com).

## **I. Package Contents**

- TD50L digital night vision scope
- Eye cup
- IPB-3 portable bag
- USB-C cable
- Power adapter
- Lens cleaning cloth
- Certificate of qualification

## **II. Description:**

Tube series digital night vision device is a daytime and night dual-use scope designed for outdoor hunting. It is equipped with a starlight-level low illuminance chip, which can restore true colors and details in both day and night. The Tube series has a variety of battery-powered solutions with long operating hours, and can be widely used for hunting, observation and positioning in low visibility conditions. It adopts a 30mm standard pipe diameter to meet the requirements of the general clamp interface.

## **III. Product Features**

- Starlight low illuminance sensor;
- High image quality;
- Infinite zoom;
- Dual power supply system, with long battery life;
- Standard 30mm pipe diameter;
- Stadiametric rangefinding;
- Long detection distance;
- Built-in memory card, supporting photo taking and video recording
- Built-in Wi-Fi module, supporting app connection
- Support PIP (picture-in-picture) function (Due to some factors, this function is not available for some regions);

- Convenient operation interface;

## IV. Device Composition

1. Eye cup
2. Eyepiece focusing ring
3. Camera button
4. Display brightness button
5. Power button
6. Image mode button
7. Rotary encoder
8. USB cap
9. Type-C interface
10. LED indicator
11. Battery holder cover
12. 18500 battery
13. Focusing ring of the objective lens
14. Lens cap

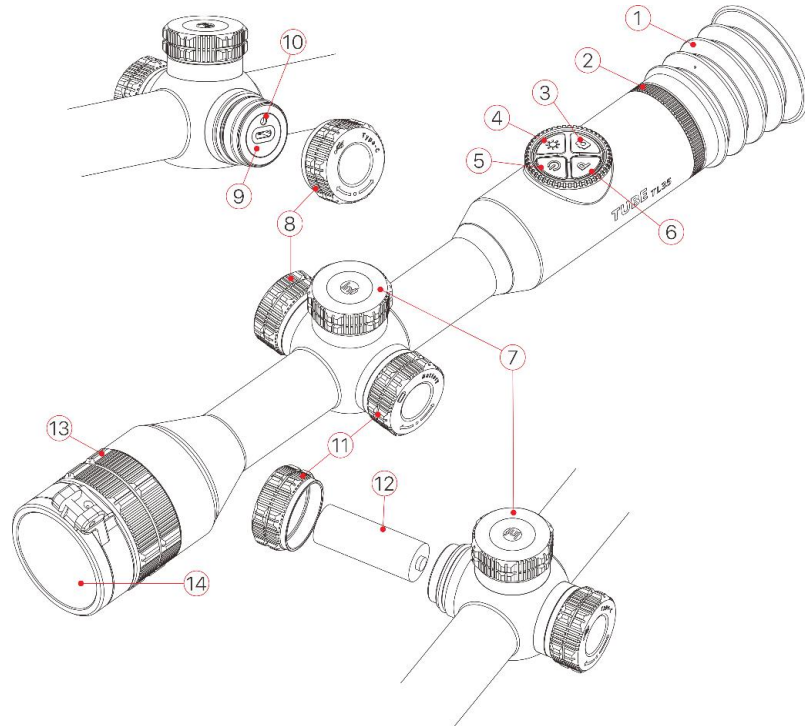

## V. Button Operations

Button	Device Status/Current Operation Mode	Press	Press and Hold	Rotate
Power Button	Powered off	---	Power on the device	---
	Home screen	Standby	Shut down the device	---
	Standby	Wake up the	---	---

		device		
	Advanced menu screen	Return to the upper menu without saving changes	_____	_____
<b>Image Mode Button</b>	Home screen	Switch the image mode	Turn on/off the PIP function	_____
<b>Display Brightness Button</b>	Home screen	Adjust the display brightness	Turn on/off the stadiametric rangefinding function	_____
<b>Camera Button</b>	Home screen	Take a photo	Turn recording on/off	_____
<b>Rotary Encoder</b>	Home screen	Open the shortcut menu	Open the advanced menu	Adjust image magnification
	Shortcut menu screen	Adjust specific parameters of a function	Save and go back to the home screen	Switch between menu options/move
	Advanced menu screen	Confirm the option parameters/Open the submenu	Save and go back to the main menu	reticle position: Clockwise: move to the left/down direction;
	Zeroing screen	Switch between the X axis/Y axis	Save and go back to the main menu	Anticlockwise: move to the right/up direction

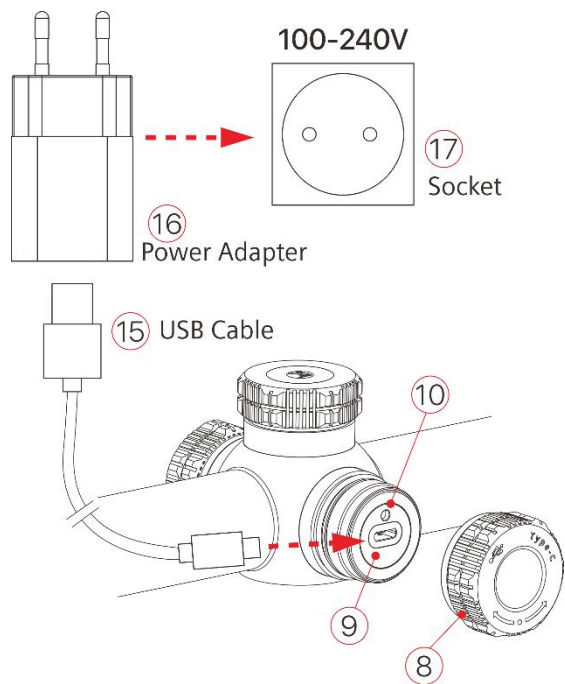

## VI. Battery Charging

The Tube series adopts a dual power supply system (built-in chargeable Lithium-ion battery pack and a replaceable 18500 battery). The normal working time of the dual power supply system can be up to 13 hours. The battery should be fully charged before first use.



### Charging the Built-in Battery

#### Package

- Turn counterclockwise to open the USB cap;
- Insert the Type-C end of the attached data cable into the Type-C socket on the Tube;
- Connect the other end of the data cable to the power adapter, and insert the adapter into a 100-240V power socket to charge the battery pack;
- When charging, a lightning charging icon  appears on the battery icon, and the LED indicator on the device is in red. When the indicator turns green, it indicates that the charging is completed.
- During use, if the battery icon turns to , it indicates that the battery level is low. Please charge the battery in time to avoid reducing the service life of the device due to over discharge of the battery.

**Note:** The USB port can only be used for charging the built-in battery pack.

### Installing 18500 battery

- Turn anticlockwise to open the battery holder cover (11);
- Install the 18500 battery (12) according to the indication label in the battery holder,

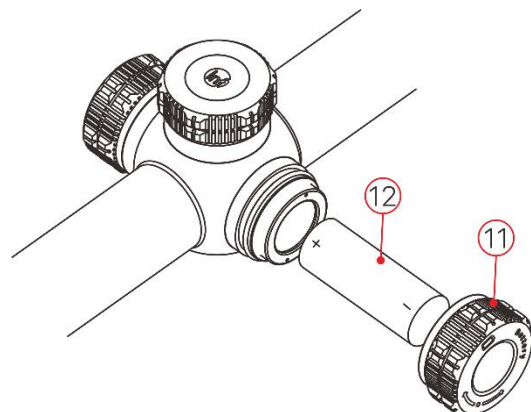

that is, the positive pole faces inward and the negative pole faces outward;

- Close the battery holder cover (11) and turn clockwise to tighten it.

## **Safety Measures**

- When charging, please use the 5V2A power adapter compatible with the device. Using any other type of adapter may cause irreversible damage to the battery or the adapter itself;
- If the device is not in use for a long time, the battery should be partially charged, not fully charged or discharged.
- Do not charge the device immediately after it is moved to a warm environment from a cold environment. Wait for 30 to 40 minutes for preheating.
- If the charger is modified or damaged, do not use it;
- The device should be charged at a temperature of 0°C to +40°C. Otherwise, the battery life will be significantly reduced.
- When charging, please do not leave the battery unattended;
- Do not connect the battery to the power supply for more than 24 hours after it is already fully charged;
- It is not recommended to connect third-party devices that consume more energy than the allowed value.
- The device is equipped with a short circuit protection system, but conditions that may lead to a short circuit should be avoided.
- The recommended operating temperature for the device is -20°C to +50°C. Do not use the device beyond this temperature range, or else, it may shorten the battery life.
- When the device is used under sub-zero temperature, the battery capacity drops. This is normal and does not indicate a defect.

## **Switching between two types of batteries**

The Tube series supports the dual power supply system: built-in Lithium-ion battery pack and replaceable 18500 battery, while supporting a USB power supply.

- If both batteries are installed in the Tube device, two battery icons are displayed on the

right of the status bar above the image, with the replaceable battery before the built-in battery. Green indicates that the device is being powered, and gray indicates that the device is not powered on.

- If the replaceable battery is not installed, only a green built-in battery icon is displayed on the status bar.
- If the replaceable battery is installed and fully charged, it will be preferred. When the replaceable battery is low, the device will switch to the built-in battery automatically.
- When the device is connected to a USB, it will switch to the external power supply USB automatically. At this time, a lightning-like charging icon is displayed on the built-in battery icon, which indicates that the built-in battery is being charged.
- When the device is in use, the replaceable battery can also be replaced. At this time, it will switch to the internal battery automatically.

## VII. External Power Supply

The Tube series supports external power supplies, such as the portable power source for a mobile phone (5V).

- Connect an external power supply to the USB port (9) of the Tube device;
- Then, the device automatically switches to the external power supply and charge the internal battery pack at the same time;
- When the external power supply is turned off, the device switches to the replaceable 18500 battery for power supply. If no replaceable 18500 battery is installed or the battery level is low, it will switch to the built-in battery pack, instead of shutdown.

## VIII. Installation and Use

### Fixed installation

**WARNING! The lens of the device must not be pointed at any sources of intense radiation energy, such as laser-emitting devices or the sun. This may damage the electronic components in the device. Damage caused by failure to comply with the operating guidelines is not covered under warranty.**



To ensure firing accuracy, please fix the Tube at a proper position on the weapon.

- The Tube series needs to be fixed with an adapter clamp, such as a simple Picatinny rail clamp provided in the package. The Tube series adopts a tubular body design with a diameter of 30mm, which is compatible with standard clamps with a diameter of 30mm, such as those of day scope. Proper tools can be used to install the Tube device according to the supplier's installation suggestions and steps.
- During installation, the installation position of the Tube device should be adjusted according to the distance between eye and eyepiece (eye relief) as specified in the specifications and the sense of use and comfort. If you fail to follow this suggestion, the eyepiece may hurt the shooter during the shooting.
- It is recommended to install the scope as low as possible, but keep it away from the barrel or other devices;
- It is recommended to use a torque wrench to tighten the screws of the installation clamps, so as to avoid damaging the scope body due to being over-tightened, and the recommended torque shall not exceed 2.5nm;
- When the scope is used for hunting, please carry out the zeroing operation first according to the instructions as specified in "**Chapter 9 "Zeroing"**" in this manual;
- When using the scope at night or in a dark environment, it is recommended to use an eye cup to avoid being found.

## **Startup and Configuration**

- Opening the lens cap (14). If the outdoor light is strong, you can close the lens cap to prevent the image from overexposure;
- Press and hold the Power button (5) for 2s to power on the device. Then, the home screen appears after 3s.
- Adjust the resolution of the icon on the display by rotating the eyepiece focusing ring (2) of the ocular lens;
- Adjust the focus length by rotating the focusing ring (13) of the objective lens;
- Setting the image mode: On the home screen, press the P button (6) to set the image palette mode, which is day-night in sequence, and the icon on the top status bar is updated

in real-time;

- Setting the display brightness: On the home screen, press the display brightness button (4) to set the screen brightness, which can be switched between level 1 to level 5, and meanwhile, a short prompt for the corresponding brightness icon appears at the bottom of the display;
- Setting the image sharpness: Press the rotary encoder (7) to go to the shortcut menu, and set the image sharpness (refer to Chapter "**Shortcut Menu**" for details);
- After using the device, press and hold the Power button (5) for 3 seconds. Then, the shutdown countdown screen appears. When the countdown icon turns from 3 to 0, the device shuts down. **When the device is powering off and saving data, do not disconnect it from the power source. Otherwise, the data cannot be saved.**
- Press the power button (5) and the device will enter standby mode. Press the power button (5) to wake it up.

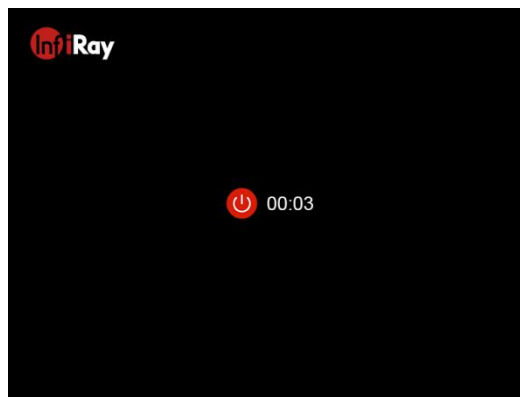

## IX. Zeroing

The Tube series adopts the "freezing" zeroing method. It is recommended to carry out the zeroing operation within the range of operating temperature of the scope.

- Fix the scope on the weapon with a frock clamp;
- Select a target at a certain distance, such as 100m, 200m, etc.;
- Adjust the scope according to the operating instructions as described in Chapter VIII

### **Startup and Configuration;**

- Select zeroing profile (refer to "**Reticle Setup-Zeroing Profile**" in the advanced menu function);

- Press and hold the rotary encoder (7) to enter the advanced menu screen, select the zeroing option, and press the rotary encoder (7) to enter the submenu of the zeroing function;
- According to the selected target distance, select or add the new zeroing distance (refer to **"Zeroing-Zeroing Distance-Set Zeroing Distance"** in the advanced menu);
- When the zeroing distance is set up, turn the encoder (7) to select the zeroing function, and press the encoder (7) to go to the zeroing screen (refer to **"Zeroing-Zeroing**

**Distance-Zeroing Screen"** in the advanced menu). The coordinate positions of the reticle (X axis and Y axis) are displayed in the upper left corner of the display;



- Shoot at the target;
- Observe the position of the actual point of impact, and assume that the red mark × in the figure on the right is the position of the point of impact (This mark is only for illustration. It should actually be a bullet hole);

- If the point of impact and the aiming point (the center point of the reticle) do not match with each other, keep the aiming position still, and meanwhile, press and hold the P button (6) and the camera button (3) to freeze the picture, and then a snow-like



freezing icon  appears on the left of the display;

- Turn the rotary encoder (7) to move the reticle, rotate clockwise to move the cursor left or down, and rotate anticlockwise to move the cursor right or up;
- Press the rotary encoder (7) to switch between the X axis and Y axis, and the position of the cursor ➤ indicates the currently selected item, with the icon turns blue;
- After moving the reticle, a little white dot appears on the display, indicating the position of the reticle before moving;
- After moving the reticle position to the actual point of impact, press and hold the rotary

encoder (7) to save the current reticle position and return to the main screen of the advanced menu;

- Repeating aiming and shooting, until the position of the point of impact is consistent with that of the aiming point.
  - **Note:** After the zeroing position is set up, you can switch the options of **zeroing distance** in the shortcut menu.

## XI. Digital Zoom

The Tube series Scope supports the Infinite zoom function of 4.0-16.0, by which you can magnify an image by 1 to 4 times.

- On the home screen, turn the rotary encoder (7) to zoom in/out the image;
- Zoom in by rotating clockwise, and zoom out by rotating anticlockwise;
- The real-time magnification in the operating process appears in the lower middle position of the display area for 2s, and meanwhile, the current magnification is updated in real time in the top menu bar;

## XII. Photo Taking and Video Recording

The Tube series is equipped with a built-in 16 GB memory space, which allows photo taking and video recording of an observed target. Image and video files will be named after time, so it is recommended to complete the system date and time settings in the advanced menu before using the photo taking and video recording function (refer to "**Advanced Menu-Settings-Date/Time**").

### Take a photo

- On the home screen, press the **camera** button (3) to take a photo. A photo icon appears in the upper right corner of the display after the picture is stuck for 0.5s;
- The images taken are saved in the built-in memory space.

### Video Recording

- On the home screen, press and hold the



**camera button (3)** to start the video recording;

- A recording icon and a prompt box showing the recording time will appear in the upper right corner of the display, with the time format as 00:00:00 (hours: minutes: seconds);
- During recording, you can also take a photo by pressing the **camera button (3)**;
- Stop the recording and save the video by pressing and holding the **camera button (3)**;
- The videos and images taken are saved in the built-in memory space.



**Note:**

- The menu can still be operated during video recording;
- All the images taken and the videos recorded are stored in the built-in memory card in the format of IMG\_HHMMSS\_XXX.jpg (image) and VID\_HHMMSS\_XXX.mp4 (video), with HHMMSS indicating hours/minutes/seconds and XXX indicating the serial number of the three-digit multimedia file;
- The serial number of the multimedia file cannot be reset;

**Caution:**

- The maximum duration of a video recording file is 10 minutes. When the duration is more than 10 minutes, the video will be automatically recorded onto a new file;
- The number of files is limited by the capacity of the built-in memory space of the device. You should check the remaining capacity of the memory card regularly, and transfer materials and images to other media to free up the space on the memory card.
- The interface icon information is not displayed on the captured video or image.

**Memory Access**

When the device is turned on and connected to a computer, it will be recognized by the computer as a flash memory card, which is used to access the memory of the device and copy images and videos.

- Connect the device to a computer through the data cable;
- Start-up the device;
- Double-click "My Computer", double-click to open the device named "Infiray"



, and then double-click to open the device name "Internal Storage"



to access the memory;



- Open the memory file, and there are different folders named after time in the format of xxxx (year) xx (month) xx (day) in it;
- In the folder are the images and videos that are taken and recorded that day;
- Select required files or folders to copy or delete.

### XIII. Status Bar



The status bar is located at the top of the image interface and displays the information related to the current operating status of the device. From left to right, there are:

1. Current image mode (☀️: day mode; 🌙: night mode)
2. Current zeroing profile and zeroing distance (e.g., A100m)
3. Current optical magnification (e.g., 4.0×)
4. Standby status and time (OFF by default)
5. Wi-Fi status (🚫: Wi-Fi is disabled; 📶: Wi-Fi is enabled)
6. Clock (You can set up date and time in the settings menu, or download the InfiRay Outdoor APP to synchronize phone time to the device)
7. The power status of the replaceable battery (18500 battery)
8. The power status of the built-in battery pack

**Note:** When the color in the icon is green , it indicates that the battery percentage is higher than 20%, and the power is sufficient. When the color in the icon is red , it indicates that the power is insufficient and you need to recharge the battery promptly. When a lightning icon  is displayed in the icon, it indicates that the device is powered by the external power supply and the built-in battery pack is being charged.

## XIV. Shortcut Menu

The shortcut menu can be used for a quick setup of the basic settings of some common functions, including reticle style, reticle color, image sharpness, and zeroing distance. Press and hold the encoder (7) to save the operation and return to the home screen.

- On the home screen, press the **rotary encoder (7)** to go to the shortcut menu screen;

Turn the **rotary encoder (7)** to switch between the following function options, and the icon background of the selected option will be highlighted:

**Image contrast:** Turn the encoder (7) to select the option, and press the encoder (7) to adjust the image contrast from level 1 to 5;

**Image sharpness:** Turn the encoder (7) to select the option, and press the encoder (7) to adjust the image sharpness from level 1 to 5;

**Zeroing distance:** Turn the encoder (7) to select the option, and press the encoder (7) to switch between the preset distances;

- Press and hold the **rotary encoder (7)** to save the changes and return to the home screen.

**Note:** In the shortcut menu, if there is no operation within 15s, the device will automatically save the changes and return to the home screen.

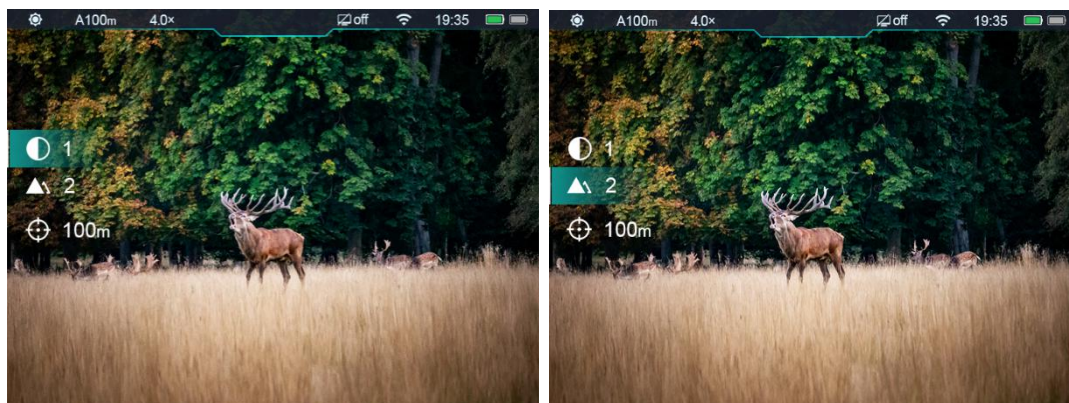





## XV. Advanced Menu:

- On the home screen, press and hold the **rotary encoder (7)** for 3s to go to the main menu;
- Turn the **rotary encoder (7)** to switch between the function options in the main menu, rotate clockwise to move down and anticlockwise to move up;
- The function options in the main menu are cyclical: when the cursor **>** reaches the last option on the first page, it will turn to the first menu option on the second page. When the cursor **>** is at the first option on the first page, it can skip directly to the last menu option on the second page by rotating the **rotary encoder (7)** anticlockwise;
- Press the **rotary encoder (7)** to modify the parameters of the current option or go to the submenu;
- The position of the cursor indicates the selected option, the icon of which will change from white to blue;
- The operation of secondary and tertiary menus is the same as above;
- In any menu screen, press and hold the **rotary encoder (7)** to save the changes and return to the upper menu. Press the **power button (5)** to return to the upper menu without saving the change;
- In any menu screen, the device will automatically return to the home screen without saving the changes when there is no operation within 15s.
- During the continuous operation of the scope, when exiting from the advanced menu, the cursor **>** remains at the position before exiting. When you restart the scope and go to the advanced menu for the first time, the cursor stays at the first menu option.

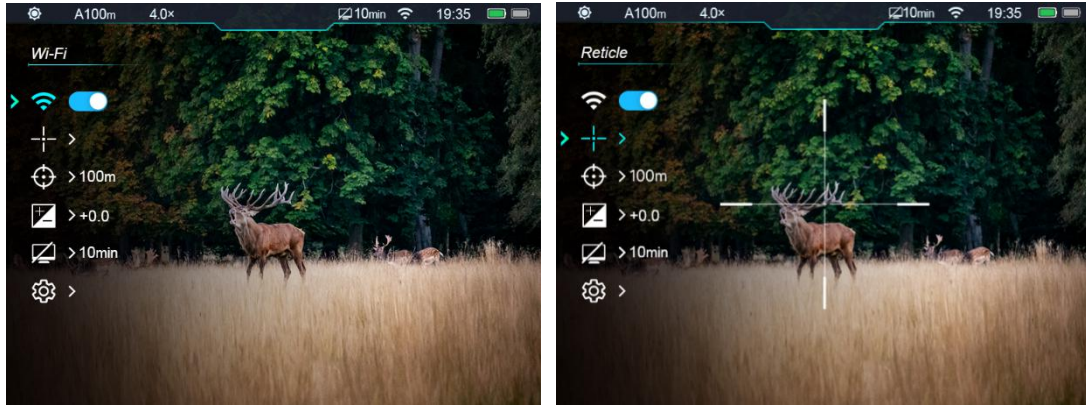



## Composition and Description of Main Menu

<p><b>Wi-Fi</b></p> 	<p><b>Enabling/Disabling Wi-Fi</b></p> <ul style="list-style-type: none"> <li>● Press and hold the rotary encoder (7) to open the <a href="#">advanced</a> menu;</li> <li>● Turn the rotary encoder (7) to select the "Wi-Fi" function option;</li> <li>● Press the rotary encoder (7) to enable/disable Wi-Fi;</li> <li>● The icon in the status bar changes accordingly after this mode is turned on or off.</li> </ul>
<p><b>Reticle</b></p> 	<p><b>Selecting Zeroing Profile</b></p> <ul style="list-style-type: none"> <li>● Press and hold the rotary encoder (7) to open the advanced menu;</li> <li>● Turn the rotary encoder (7) to select the "Zeroing Profile" function option;</li> <li>● Press the rotary encoder (7) to open the secondary menu of "Zeroing Profile";</li> <li>● Turn the rotary encoder (7) to select one from the three zeroing profiles (A, B, C);</li> <li>● Press the rotary encoder (7) to confirm the selection, and return to the main menu.</li> <li>● The operation for reticle style and reticle color is the same as that for zeroing, which can be set up separately.</li> </ul>



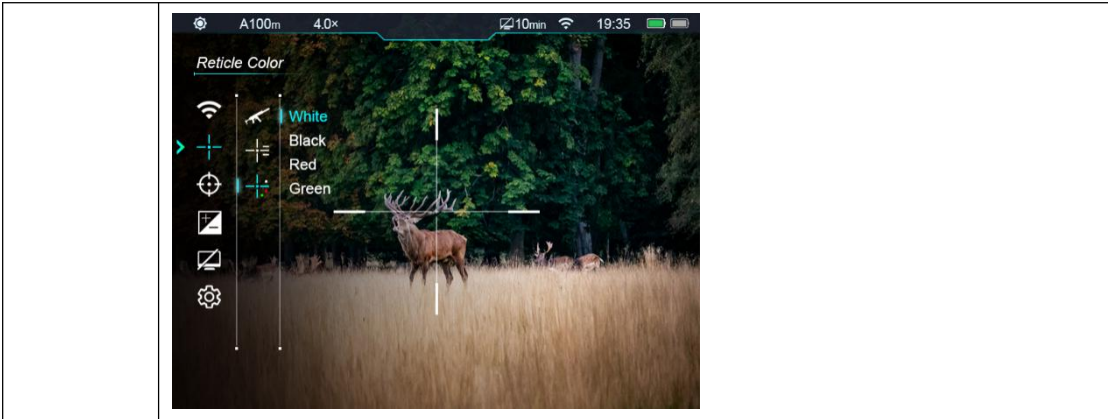

Please set up the zeroing profile and zeroing distance before carrying out any zeroing operation.

The Tube series supports any zeroing distance between 1 and 999 meters.

- Press and hold the rotary encoder (7) to open the advanced menu;
- Turn the rotary encoder (7) to select the "Zeroing" function option;
- Press the rotary encoder (7) to open the secondary menu of the zeroing function, where displays 3 zeroing distances;
- Turn the rotary encoder (7) to select the zeroing distance according to the distance set for the target;
- Press the rotary encoder (7) to confirm the zeroing distance, and open the zeroing distance submenu, including two options, that is "Zeroing" and "Zeroing Distance";

**Zeroing**

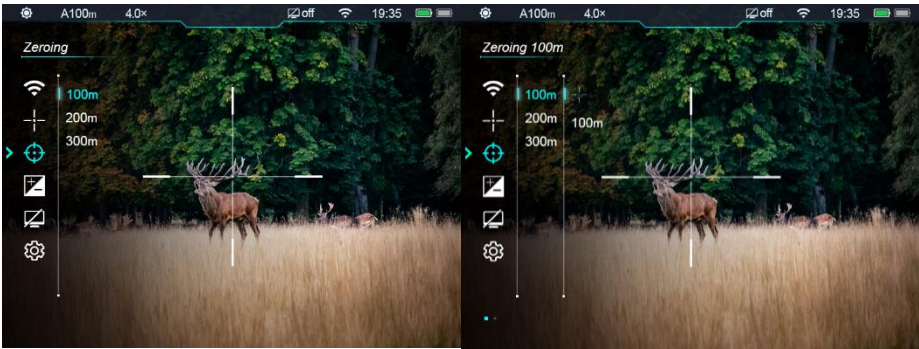



**Zeroing**



- If the preset zeroing distance is consistent with that displayed on the device, you can perform zeroing directly following the steps as below:
- Turn the rotary encoder (7) to select the **zeroing** function ;

		<ul style="list-style-type: none"> <li>● Press the rotary encoder (7) to go to the zeroing screen;</li> <li>● The X axis and Y axis coordinates of the reticle are displayed on the top left corner of the display;</li> <li>● Aim the reticle center of the scope at the bull's eye at the target distance and shoot, and then observe the position of the actual point of impact;</li> <li>● Keep the aiming position still, and meanwhile press and hold the <b>image mode button (6)</b> and the <b>camera button (3)</b> to freeze the picture, and meanwhile, the freezing icon is displayed on the display;</li> <li>● Turn the rotary encoder (7) to move the reticle position, until the reticle center aims at the position of the point of impact. For details, refer to <b>Chapter IX "Zeroing"</b>.</li> </ul> 
	<p><b>Setting the Zeroing Distance</b></p>	<ul style="list-style-type: none"> <li>● If the zeroing distance is not consistent with the preset target distance, this option can be used for setting.</li> <li>● Select an invalid zeroing distance, press the encoder (7) to open its submenu;</li> <li>● Turn the encoder (7) to select the option "<b>Setting the Zeroing Distance</b>";</li> <li>● Press the rotary encoder (7) to activate the zeroing distance reset function, and then two small triangle</li> </ul>

		<p style="text-align: center;">▼ 0 ▲</p> <p>symbols ▲ are displayed above and below the number;</p> <ul style="list-style-type: none"> <li>● Turn the encoder (7) to set the number value of the current position, which can be switched between 0 to 9;</li> <li>● Press the rotary encoder (7) to switch between the positions of hundreds, tens and ones digits;</li> <li>● After setting, press and hold the encoder (7) to save the setting and exit. The cursor returns to the zeroing option, and meanwhile the zeroing distance changes accordingly;</li> <li>● Besides, the status bar updates to the new zeroing distance synchronously.</li> </ul> 
<p><b>Standby</b></p> 	<p><b>Setting the standby state and duration</b></p> <ul style="list-style-type: none"> <li>● In the advanced menu, turn the rotary encoder (7) to select the "<b>Standby</b>" option;</li> <li>● Press the rotary encoder (7) to open the submenu for standby setting, including four options, respectively 10min, 20min, 30min and off;</li> <li>● Turn the rotary encoder (7) for selection;</li> <li>● Press the rotary encoder (7) to confirm the selection, and then the selected option is displayed in the top status bar;</li> <li>● If Off is selected, the standby function is disabled;</li> </ul> <p><b>Note:</b></p> <ul style="list-style-type: none"> <li>- When the device is in the following status, the standby mode is activated automatically: up &gt; 70° or down &gt; 70°, and left &gt; 30° or right &gt; 30°;</li> </ul>	

- When the device is in the shooting status, the standby mode is disabled.



This function is used to set the language, units of measure, status auto hiding, factory reset, and device information query.

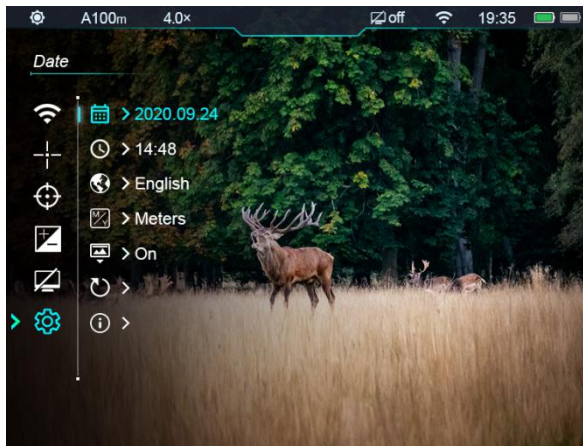

## Settings









## Date





### Setting the system date



- Press the rotary encoder (7) to open the secondary menu of "Settings".
- Turn the rotary encoder (7) to select "**Date**";
- Press the rotary encoder (7) to activate the date reset function, with the time in the format of YY/MM/DD.
- Turn the rotary encoder (7) to set the correct year, month and date;
- Press the rotary encoder (7) to switch between year, month and date;
- After setting, press and hold the rotary encoder (7) to save changes and exit the date reset function.

		
<p>Time</p> 		<p><b>Setting the system time</b></p> <ul style="list-style-type: none"> <li>● Press the rotary encoder (7) to open the secondary menu of "Settings".</li> <li>● Press the rotary encoder (7) to select "<b>Time</b>". The 24-hour system is used with the hour and minute displayed.</li> <li>● Press the rotary encoder (7) to activate the time reset function;</li> <li>● Turn the rotary encoder (7) to set the correct hour and minute;</li> <li>● Press the rotary encoder (7) to switch between the hour and minute;</li> <li>● After setting, press and hold the rotary encoder (7) to save changes and exit the time reset function;</li> <li>● After setting time, the time in the status bar changes accordingly.</li> </ul> 
<p>Language</p> 		<p><b>Select Language</b></p> <ul style="list-style-type: none"> <li>● Press the rotary encoder (7) to open the secondary menu</li> </ul>

		<p>of "Settings".</p> <ul style="list-style-type: none"> <li>● Select "<b>Language</b>", and press the rotary encoder (7) to open the secondary menu for language selection;</li> <li>● Turn the rotary encoder (7) to switch between English and Russian;</li> <li>● Press the rotary encoder (7) to confirm and save the selection, and return to the menu screen;</li> </ul> 
	<p><b>Units of Measure</b></p> 	<p><b>Selecting the Units of Measure</b></p> <ul style="list-style-type: none"> <li>● Press the rotary encoder (7) to open the secondary menu of "Settings".</li> <li>● Select "<b>Units of Measure</b>", and press the rotary encoder (7) to open the secondary menu for units setup;</li> <li>● Turn the rotary encoder (7) to switch between meter and yard;</li> <li>● Press the rotary encoder (7) to confirm and save the selection, and exit;</li> </ul> 
	<p><b>Status Auto</b></p>	<p><b>Enabling/Disabling status auto hiding</b></p>

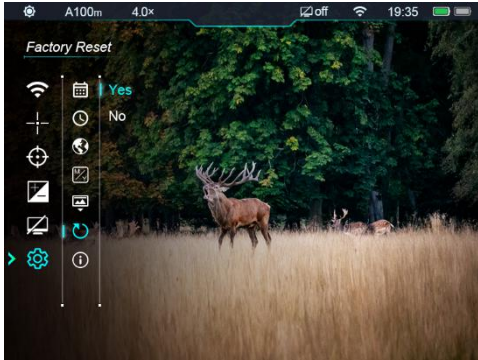

<p><b>Hiding</b></p> 	<ul style="list-style-type: none"> <li>● Press the rotary encoder (7) to open the secondary menu of "Settings".</li> <li>● Select "<b>Status Auto Hiding</b>", and press the rotary encoder (7) to open the secondary menu for status auto hiding;</li> <li>● Turn the rotary encoder (7) to select On or Off;</li> <li>● Press the rotary encoder (7) to confirm the selection, and return to the main menu screen;</li> </ul> 
<p><b>Factory Reset</b></p> 	<p><b>Restoring factory default settings</b></p> <ul style="list-style-type: none"> <li>● Press the rotary encoder (7) to open the secondary menu of "Settings".</li> <li>● Select "<b>Factory Reset</b>", and press the rotary encoder (7) to open the secondary menu for factory reset;</li> <li>● Press the rotary encoder (7) to select "Yes" for restoring factory settings or "No" for canceling the operation;</li> <li>● Press the rotary encoder (7) to confirm the selection;</li> <li>● If "Yes" is selected, the scope will re-start automatically;</li> <li>● If "No" is selected, the operation is canceled and return to the upper menu.</li> </ul> <p>After the Factory Reset is selected, the following functions will be restored to default settings:</p> <ul style="list-style-type: none"> <li>- Image Mode: Colour</li> <li>- Zeroing Distance: A100</li> </ul>

		<ul style="list-style-type: none"> <li>- Digital Zoom: <math>\times 4.0</math></li> <li>- Standby: Off</li> <li>- Wi-Fi: Off</li> <li>- Language: English</li> <li>- Unit of Measure: Meter</li> <li>- Status Auto Hiding: Off</li> </ul> 
	<p><b>Info</b></p> 	<p><b>Querying device information</b></p> <ul style="list-style-type: none"> <li>● Press the rotary encoder (7) to <b>open</b> the secondary menu of "General".</li> <li>● Turn the rotary encoder (7) to select <b>"Info"</b>;</li> <li>● Press the rotary encoder (7) to query the relevant information about the current scope;</li> <li>● Press and hold the rotary encoder (7) to exit and return to the upper menu.</li> </ul>

## 16. PIP

Picture-in-Picture (PIP) provides a floating window independent of the full screen. This window shows part of the image which is enlarged to  $2\times$  in a certain area centered on the reticle of the main image.

- On the home screen, press and hold the **image mode button (6)** to enable or disable PIP.



- After enlarging the image on the home screen by turning the **encoder (7)**, the image shown in the PIP window is also enlarged to 2×.

\*Due to some factors, this function is not available for some regions.

## 17. Stadiametric Rangefinding

The Tube series provides stadiametric rangefinding, which allows you to calculate the approximate distance from a target with a known size.

- On the home screen, press and hold the **display brightness button (4)** to enable or disable this function;
- After this function is enabled, two lines used for measuring appear in the middle part of the image, and three icons of pre-configured objects and the values of measurement distance are displayed on the right side.
- Three pre-defined target values are provided as follows:
  - Deer: 1.7m high
  - Wild boar: 0.7m high
  - Hare: 0.2m high
- Adjust the device to move the target in the center of the display area. Turn the rotary encoder (7) clockwise to enlarge or anticlockwise to reduce the width of the measurement lines, so that the target is completely between the measurement lines. When you adjust the width of the measurement line, the rangefinding data on the right changes accordingly.
- The color and center position of the measurement line are synchronized with that of the reticle;
- If you want to change the units of measure, please refer to Advanced Menu-Settings-Units of Measure for modification;
- Press and hold the display brightness button (4) to exit this function.



## XVIII. Status Auto Hiding

This function is used to hide GUI with reticle displayed only so that there is no blocking on the image.

- In the advanced menu, turn the rotary encoder (7) to select the "Settings" option;
- Press the rotary encoder (7) to open the secondary menu of "Settings", and turn the rotary encoder (7) to select "Status Auto Hiding";
- Press the rotary encoder (7) to open the submenu of "Status Auto Hiding" and then select On or Off.
- After the status auto hiding is enabled, all GUI icons including the status bar will be automatically hidden and only the image and reticle are displayed if there is no operation within 8s.
- Press or press and hold any button to invoke the GUI information.
- You can operate the buttons and the menu only after the GUI information is displayed.

## XIX. Wi-Fi

The Tube series has a built-in Wi-Fi module. The device can connect wirelessly to a mobile apparatus (laptop or smartphone) via Wi-Fi.

- In the advanced menu, enable Wi-Fi. For detailed operations, refer to "**Advanced Menu-Wi-Fi**".
- After the Wi-Fi of the scope is enabled, search for the Wi-Fi signal with the name "Infray\_XXXXXX" on the mobile device, among which XXXXXX is a 6-bit serial number composed of digits and letters.
- Select the Wi-Fi, enter the password and connect. The initial password is 12345678;
- After Wi-Fi access, you can control the scope via the mobile app.



## Setting Wi-Fi name and password

The Tube series allows you to change the name and password of the device Wi-Fi in the app.

- After the scope is connected to the mobile device, locate the "Settings" icon  in the **InfiRay Outdoor** image screen and tap it to open the "Settings" screen;
- In the text box, enter and submit the new Wi-Fi name (SSID) and password.
- After submitting the change, reset the device to activate the setting.

**Caution!** After the device is restored to the factory setting, the name and password of the Wi-Fi will also be restored to the default factory setting.

## XX. Product Update and Description to APP

The Tube series thermal imager supports control with an app. You can transmit images in real time, operate the device, and update the program by connecting a smartphone or laptop via Wi-Fi.

You can download the user manual of InfiRay Outdoor at our official website ([www.xinfrared.com](http://www.xinfrared.com)).

You can also test and update the firmware program of the product via the InfiRay Outdoor app or download it on our official website.

### About InfiRay Outdoor

- You can download and install the InfiRay Outdoor app on the official website ([www.xinfrared.com](http://www.xinfrared.com)) or an app store. Alternatively, you can scan the QR code below to download it for free.



- After installing the app, open it.
- If your device has been connected to a mobile device, enable mobile data on it. After the device accesses the Internet, an update prompt will be displayed automatically. Click Now to download the latest version immediately or click Later.
- InfiRay Outdoor saves the last connected device automatically. Therefore, once you open InfiRay Outdoor, it automatically detects an update in the background even when the scope is not connected to a phone or laptop. If an update is available and the mobile device accesses the internet, you can download the update first. After the download is completed, the scope will be connected to the mobile device, the version will be updated automatically.
- After the update is installed, the device will restart and enter the operation mode.

## **XXI. Technical Inspection**

Perform a technical inspection to check the following items each time before you use the device:

- Exterior of the device (no crack on the enclosure).
- Lens and eyepiece (no crack, oil, stain, or other sediments)
- Status of the rechargeable battery (fully charged in advance) and electrical contact (no salinization or oxidation).

## **XXII. Product Maintenance**

The device must be maintained in the following ways at least twice each year:

- Wipe the surface of metal and plastic parts to clear off dust and dirt by using a cotton cloth. Apply silicone grease if required.
- Use non-greasy organic solvent to wash the electric contact and slot of the battery.
- Check the glass surface of the eyepiece and lens. If necessary, clear off the dust and sand on the lens (preferably using a non-contact method). Use a specialized wiping tool and solvent to clean the optical surfaces.

## XXIII. Troubleshooting

The following table lists all problems that are likely to occur during device operation. Check and address problems by referring to this table. If faults not included in this table occur or you cannot fix the fault, return the device to the vendor or supplier for troubleshooting.

<b>Fault</b>	<b>Possible Causes</b>	<b>Solutions</b>
The scope can not be started	The battery is out of charge	Charge the battery
The device cannot be powered by using an external power supply.	The USB cable is damaged	Replace the USB cable
	The external power supply is insufficient	If necessary, check the external power supply
Images are unclear, vertical lines are present, or the background is not even	Calibration is required	Calibrate the images as instructed in Section 9 of the user manual
Images are too dark	The display is not bright enough	Adjust the display brightness
Icons are clear but images are blurry	The lens is not focused	Rotate the lens focus ring to adjust the focus
	The inner or outer optical surface of the lens is dusted or iced	Wipe the outer optical surface by using a soft cotton cloth or leave the scope to dry in a warm and dry environment for more than 4 hours
The position of the reticle moves after shooting	The scope or the fixing clamp is not installed firmly	<p>Check whether the scope is installed firmly.</p> <p>Ensure that the bullet type and caliber you use are consistent with that used for zeroing.</p> <p>If you perform zeroing in summer but use the scope in winter (or vice versa),</p>

		the zeroing point may move slightly.
The scope can not focus	Set error	<p>Set the scope according to the contents as specified in "<b>Startup and Image Setup</b>".</p> <p>Check the outer surface of the objective lens and eyepiece, and if necessary, wipe off any dust and frost on it.</p> <p>In cold weather, a special antifogging coating can be applied (such as those used on eyeglasses or car rearview mirrors).</p>
The device cannot connect to a smartphone or computer	The Wi-Fi password is incorrect	Enter the correct password
	There are too many Wi-Fi networks in the range of the device, which may cause interference	To enable stable network access, you are advised to move the device to an area with a limited number of Wi-Fi networks, or an area without Wi-Fi coverage
Wi-Fi signals are lost or interrupted.	<p>The device is beyond Wi-Fi coverage.</p> <p>There is blocking (such as concrete walls) between the device and the receiver.</p>	Move the device to a place where you can receive Wi-Fi signals.
The observed target disappears	You are observing the target through the glass	Observe the target directly without the presence of glass
The image quality is poor or the detection range shortens	These problems are likely to occur when you use the device in harsh weather (such as snow, rain, and fog).	