

DOCTER® Target Optics

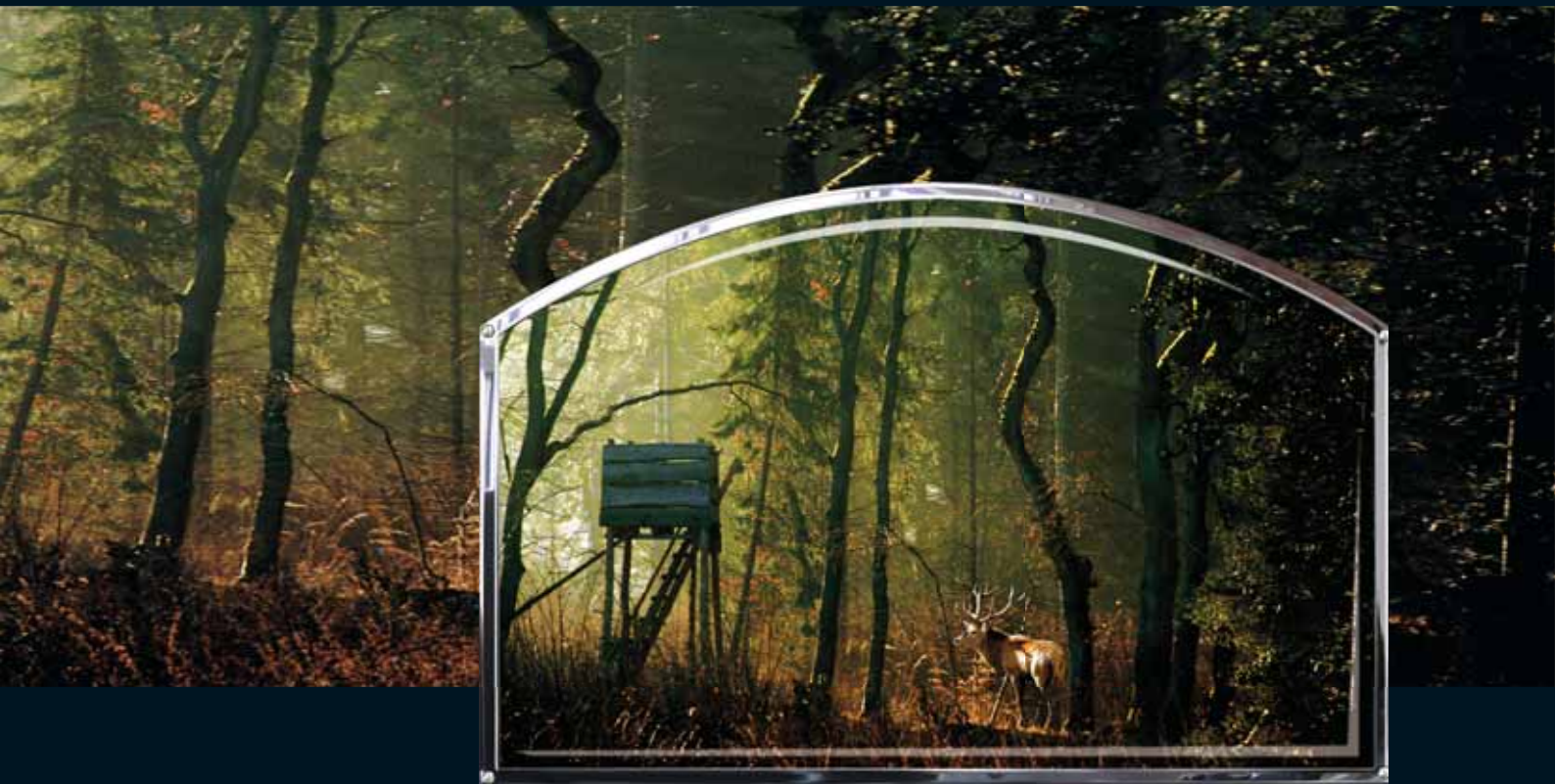



Index

DOCTER® High-Performance Optical Systems Success by Precision	4
DOCTER® Riflescopes Sport DOCTER®sport 1-Inch Center Tube Diameter	8
DOCTER® Riflescopes Hunt DOCTER® Riflescopes DOCTER®classic Riflescopes with Fixed Magnification Riflescopes with Variable Magnification Riflescopes with Illuminated Twilight Reticle DOCTER®basic shiftcontrol DOCTER®comfort Riflescope with automatic reticle illumination control DOCTER®unipoint Riflescopes with Digital Illuminated Daylight Reticle	12 14 15 16 18 20 22
DOCTER® Reflex Sights DOCTER®sight Reflex Sights DOCTER®sight II plus DOCTER®sight III	28 29 30
Accessories and Technical Specifications Accessories Technical Specifications at a Glance	34 36

DOCTER® High-Performance Optical Systems Success by Precision

Under the brand name DOCTER®, Analytik Jena AG continued a proud tradition in the development and manufacture of opto-electronic consumer products at the production facilities of Carl Zeiss first in Jena and later in Eisfeld. A success story with optical appliances that already lasts for 150 years is an expression of a great wealth of experience in optics, mechanics and electronics. For Analytik Jena, to continue this tradition with passion and an innovative spirit is incentive and commitment at the same time. The portfolio of the DOCTER® high-performance optical systems today combines classic products such as binoculars and riflescopes with modern opto-electronic appliances such as miniaturized sight systems or night vision technology.



DOCTER® Riflescopes | Sport



DOCTER®sport 1-inch Center Tube Diameter



DOCTER® 8 – 25 × 50
The long-range specialist.

Riflescopes for target shooters must meet very special requirements. Peak sports performances can only be achieved with a combination of precision and functionality. DOCTER®sport riflescopes impress with their imaging performance, highly precise mechanics and balanced design. Developed for sporty shooting disciplines, DOCTER®sport target sights are matched to this application. The reticle position on the ocular image level increases precision by means of a low extent of target coverage.

DOCTER®sport with 1-inch centre tube diameter

Model	3 – 9 × 40	3 – 10 × 40	4.5 – 14 × 40	8 – 25 × 50
Parallax balancing	100 m fixed	100 m fixed	variable	variable
Field of vision (m/100m)	11.4 – 3.9	11.4 – 3.8	7.8 – 2.6	4.4 – 1.5
Rail (optional)	–	–	–	–
Center tube diameter (mm)	25.4 (1")	25.4 (1")	25.4 (1")	25.4 (1")
Weight (g)	515	515	625	775

Eyepiece

Magnification ring and diopter adjustment are rubber-armoured in a slip-proof manner for a reliable and quick adjustment. The magnification scale is placed in a sloping position, thus enabling the set values to be read also while the weapon is in aiming position.



Target Turrets

Target turrets are optionally available for the exceedingly precise reticle adjustment of the DOCTER®sport models. They facilitate a quick and well readable distance adjustment of the reticle.



Lens with Parallax Adjustment

The highly magnifying models of the DOCTER®sport riflescopes are equipped with a parallax balancing mechanism on the lens. Thanks to a rubber armour it is particularly slip-proof and the magnification scale that is placed in a sloping position enables the set values to be read while the weapon is in aiming position.



DOCTER® Riflescopes | Hunt



DOCTER® Riflescopes

Excellent Performance from Jena

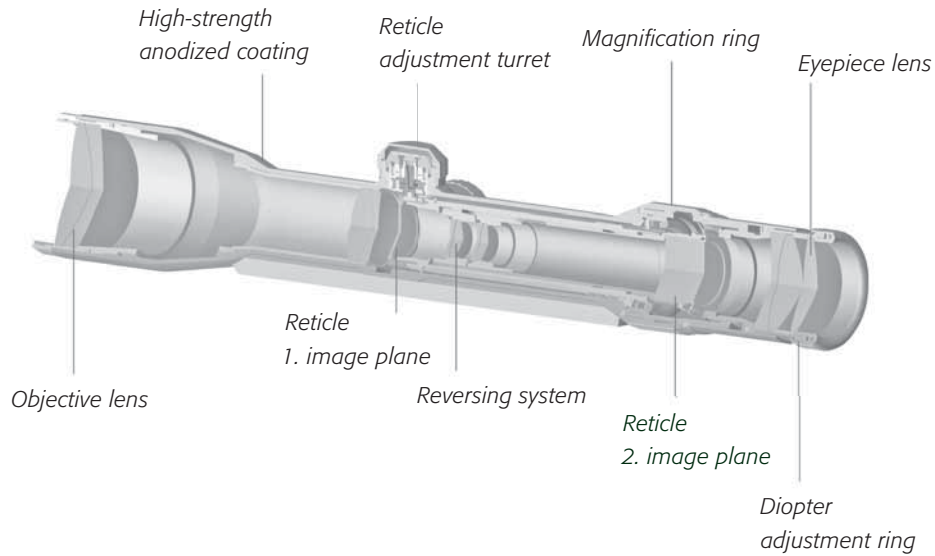

Top Optical Systems for Hunting – Made in Germany

DOCTER® riflescopes are characterized by superior optical and technological performance. Many years of experience in precision engineering and optics have spawned riflescopes which live up to the highest quality standards. The precise matching of mechanics and optical system, paired with an excellent imaging performance turns DOCTER® riflescopes into reliable companions on all continents of the earth. Tubular bodies made of aviation aluminium and high-performance optical components are able to withstand extreme climatic conditions. Only 100 % tested riflescopes leave the factory in Eisfeld. This assures a quality standard the criteria of which are defined by quality standard DIN EN ISO 9001:2008.

The following holds true for all DOCTER® riflescopes

- high-strength, hard-wearing hard anodized surface,
- dust and pressure-tight, weather resistant and climate proof due to nitrogen filling,
- centered reticle,
- absence of parallax at 100 m,
- square, adequately dimensioned reticle adjustment range,
- coating of all optical surfaces with DOCTER®multitop.

Diopter Adjustment Ring

Compensation of ametropia with at least 2.5 diopters. Thanks to the wide rubber ring at the eyepiece end, the risk of injury inflicted during firing is minimised.



Magnification Ring

Variable riflescopes are able to perform continuous changes in magnification without image jump silently and without play. The marked elevation permits the marksman to estimate the degree of magnification even in the dark.



Reticle Adjustment

The precise steps of the noiselessly adjustable snap-in locking device and the indicating dial for an easy, reliable and accurate retrieving of the zero point guarantee an exactly reproducible hitting point correction.



Transmission Measurement of a DOCTER® Rifle Scope

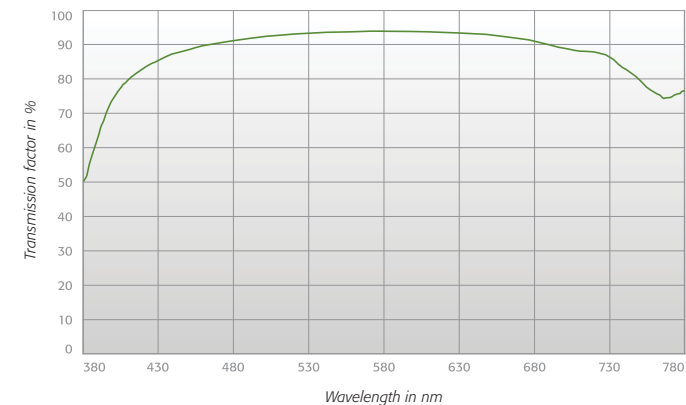

DOCTER®classic Riflescopes with Fixed Magnification



DOCTER® 6 × 42
The light riflescope for daylight hunting.

The elegant traditionalists of the DOCTER® product line do not only convince by their optical and mechanical performance, but especially by their classic design. The 26 mm center tube diameter lends this line a slender, elegant and light look. For this reason, these riflescopes are particularly suited for use on traditional break-barrel rifles and perfectly complement the former's overall appearance. The 6 x or 8 x magnification guarantees a wide range of hunting applications.

DOCTER®classic with fixed magnification

Model	6 × 42	8 × 56
Field of vision (m/100m)	6.6	5.0
Rail (optional)	Prism rail	Prism rail
Center tube diameter (mm)	26	26
Weight (g)	360	490

DOCTER®classic Riflescopes with Variable Magnification



DOCTER® 3 – 12 × 56
*The specialist for raised hide hunting.
Usable even if there is little light for shooting and always successful.*

Traditions evolve further. DOCTER®classic riflescopes with variable magnification open up a wider range of applications for the hunter. Variable riflescopes cover a large portion of practical hunting applications. Fourfold magnification factor, continuous change of magnification, free of play mechanics and brilliant optical characteristics underline the functionality and practical suitability of this model series. A large number of models is available to choose from, ranging from rifle-scopes for the driven hunt for fast, reliable shots to the light-gathering raised hide riflescope.

DOCTER®classic with variable magnification

Model	1 – 4 × 24	1.5 – 6 × 42	2.5 – 10 × 48	3 – 12 × 56
Field of vision (m/100m)	27.0 – 10.6	19.1 – 7.1	12.4 – 4.2	9.0 – 3.5
Rail (optional)	–	Prism rail	Prism rail	Prism rail
Center tube diameter (mm)	30	30	30	30
Weight (g)	410	480	580	600

DOCTER®classic Riflescopes with Illuminated Twilight Reticle



DOCTER® 8 × 56, “wild boar scope”
The riflescope gathering the most light for raised hide hunting.

DOCTER®classic with illuminated twilight reticle

Model	8 × 56 “wild boar scope”	2.5 – 10 × 48	3 – 12 × 56
Field of vision (m/100m)	5.0	11.3 – 4.2	9.0 – 3.5
Rail (optional)	Prism rail	Prism rail	Prism rail
Center tube diameter (mm)	30	30	30
Weight (g)	550	620	660

Because hunting often continues into the hours of the evening or night, it is necessary to create sighting mechanisms assisting the eye in these lighting conditions. DOCTER®classic riflescopes offer exactly this assistance. The use of high-performance optical systems that offer a high transmission in conjunction with the DOCTER®multitop coating guarantee a high yield of light.

With the illuminated twilight reticle, DOCTER® offers an additional element for reliable and accurate shooting: a reticle illumination that is adapted to the eye's brightness sensation at night. This illumination technology guarantees a perfect perceptibility of the hit point position on the target even under difficult lighting conditions.

The DOCTER® illuminated twilight reticle

- offers a low power consumption,
- does not show any dark phases during the dimming process,
- illuminates evenly, without outshining,
- is sturdy thanks to hard gold plated contact tracks,
- is equipped with a palpable intensity control.

Intensity Control of the DOCTER® Illuminated Reticle

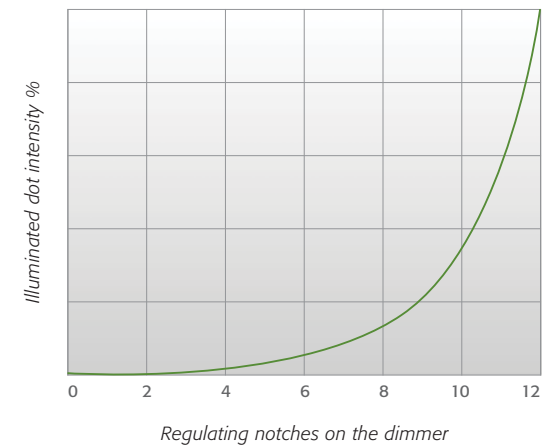

DOCTER®basic

Everything you need in a rifle scope



DOCTER®basic 3-12x56

Functional, robust, bulletproof, climate-resistant, high-contrast, brilliant, sharply defined edges. Qualities that distinguish modern high-performance scopes. DOCTER®basic is the name for target scopes with these qualities. DOCTER®basic target scopes are the basis for a solid hunting experience. They combine optical and mechanical precision with an intuitive operating concept. The various models cover a broad spectrum, from flush hunting scopes to all-round scopes and high-power target scopes. The continuously adjustable dimmable illuminated dot enables optimal visibility in all light conditions. No over-illumination at night and always visible during the day – the basis for a well-placed shot.

DOCTER®basic

Model	1-4x24	1.5-6x42	2.5-10x50	3-12x56
Field of vision (m/100m)	31.0-10.6	19.1-7.0	11.3-4.2	9.4-3.5
Rail (optional)	-	-	-	-
Center tube diameter (mm)	30	30	30	30
Weight (g)	490	560	640	680

DOCTER®basic shiftcontrol

Flexible, intuitive, safe

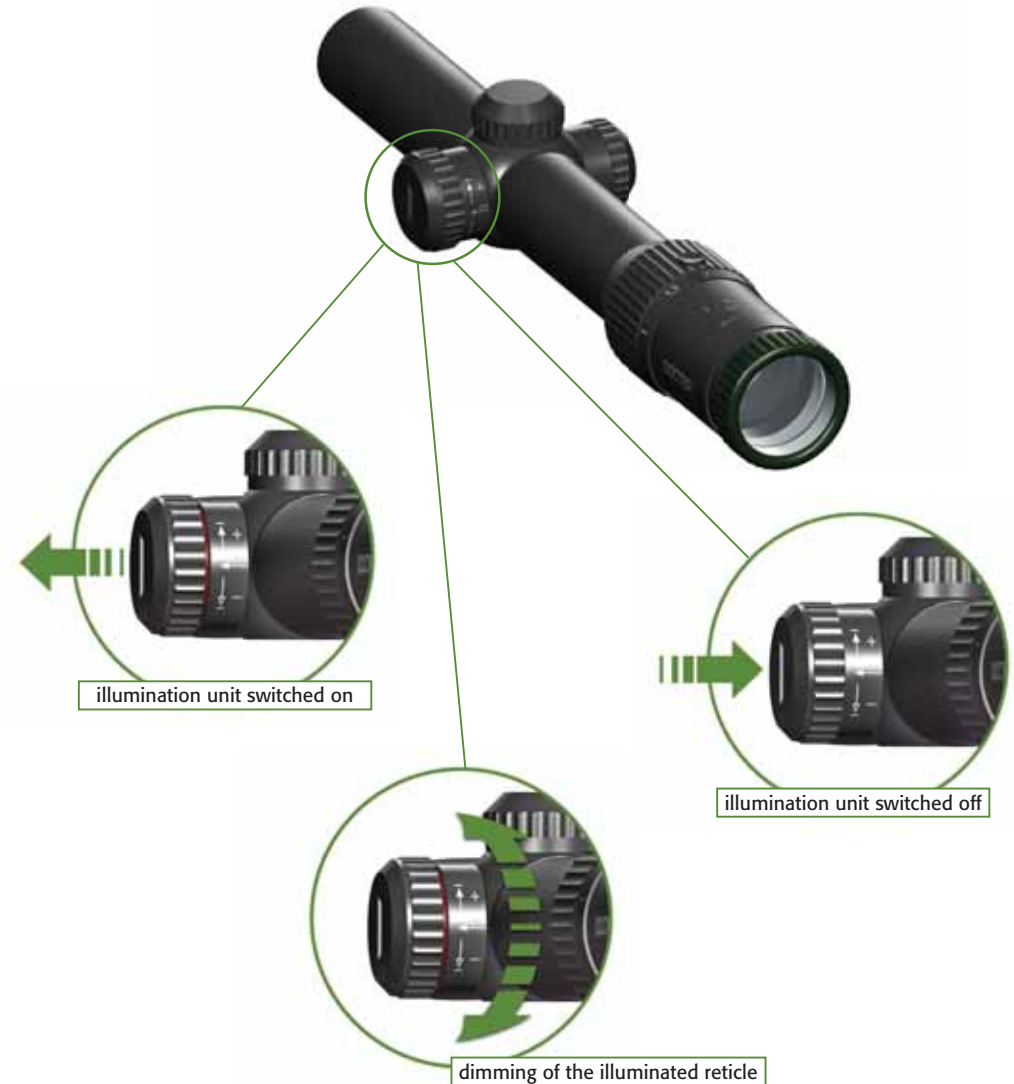

DOCTER®comfort 1–4x24

With a focus on the essential



DOCTER®comfort 1 – 4x24

The DOCTER®comfort technology combines the well-established automatic reticle illumination control of the DOCTER®sight with a riflescope for the special requirements of drive hunting. The aim is to allow the marksman to focus completely on the hunting situation. In the aiming position, the reticle is immediately ready for use and is always set to the correct intensity. There is no need for continuous manual readjustment. The sensor performance is adapted to the physiological eye sensitivity and thus prevents an over-illumination of the target by the reticle. If necessary, the reticle intensity can also be adjusted manually to your personal perception

DOCTER®comfort 1 – 4x24

Model	1 – 4x24
Field of vision (m/100m)	31.0 – 10.6
Rail (optional)	–
Center tube diameter (mm)	30
Weight (g)	490

DOCTER®auto intense control



auto intense illumination

The auto intense illumination control detects the brightness in the target area and calculates the perfect reticle brightness within fractions of a second. The status of the power supply is continuously detected. In case of low battery voltage, a flashing signal of the reticle indicates that a battery change is recommended.

position sensor

If the weapon is not used and thus placed down, the integrated position sensor switches off the reticle automatically. Switch-off is carried out in vertical position if the angle is larger than $+45^\circ$ and -75° and for tilting if the angle is larger than $\pm 45^\circ$.

DOCTER®unipoint Riflescopes with Digital Illuminated Daylight Reticle



DOCTER®unipoint 2.5 – 10 × 50
The allround riflescope for stalk and raised hide.

Reticle Illumination at the Push of a Button

tipcontrol® – the innovative DOCTER® illumination unit is setting standards when it comes to target acquisition and operating convenience. Operation of the illumination unit is effected with the push of a button. It is possible to adapt the dot brightness to the surrounding lighting conditions while the weapon is in aiming position. The dynamic range of the illuminated dot intensity is adapted to all kinds of lighting conditions. The illuminated daylight reticle is therefore equally suited for wintery battues and nocturnal raised hide hunting. The red colour of the reticle is quickly perceived by the marksman, thus guaranteeing a reliable target acquisition. The automatic shut-off system of the reticle illumination after 180 minutes considerably increases battery life. In addition, a battery holder is located in one of the elevated caps, so that it is possible to carry along a spare battery at all times. The dual memory function saves the last brightness value set, which is retrieved the next time the reticle is switched on.

DOCTER®unipoint with digital illuminated daylight reticle

Model	1 – 4 × 24	1.5 – 6 × 42	2.5 – 10 × 50	3 – 12 × 56
Field of vision (m/100m)	31.0 – 10.6	19.1 – 7.0	11.3 – 4.2	9.4 – 3.5
Rail (optional)	Z-rail	Z-rail	Z-rail	Z-rail
Center tube diameter (mm)	30	30	30	30
Weight (g)	490	560	640	680



A digital adjustment of the illuminated dot according to the eye's physiology can be triggered with the push of a button.



Magnification 3 ×



Magnification 6 ×



Magnification 12 ×

Precision and Innovation Rolled Into One

DOCTER®unipoint riflescopes unite precision mechanics and electronic innovation. Reducing the angle of rotation when changing the magnification permits a quick and convenient magnification adjustment.

The illuminated daylight reticle on DOCTER®unipoint models is located on the ocular image plane (second image plane) and is not enlarged during a change in magnification. As a result, the reticle covers relative less of the game body when the target is magnified. A precise shot application is thus guaranteed.

When selecting reticle 4 – 0, the bar reticle is located on the lens image plane (first image plane). The bars are magnified proportionally, thus permitting the distance to be estimated by means of the horizontal bar distance.

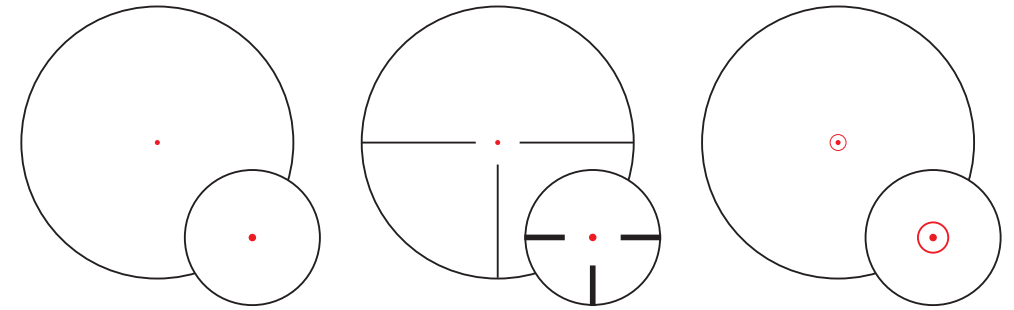

Reticle Models 0 and 4 – 0

On DOCTER®unipoint models, the illuminated dot is always located on the ocular image plane. Optionally, DOCTER®unipoint riflescopes can be equipped with reticle 0 (illuminated dot only) or reticle 4 – 0 (illuminated dot with bar reticle on the first image plane).

Reticle Model Circle Dot

For DOCTER®unipoint models 1 – 4 x 24 and 1.5 – 6 x 42, the circle dot reticle is additionally available. The combination dot/circle is also located on the ocular plane and is equipped with the typical tipcontrol® performance characteristics.

The Well-Proven Z-Inside Rail

All DOCTER®unipoint riflescopes are available with the well-proven Z-inside rail. Constructed in the same way as the Zeiss inside rail, this mounting version demonstrates absolute functionality, aesthetics and a shot-proof fit.

Extent of coverage DOCTER®unipoint at 100 m

DOCTER®unipoint 1 – 4 × 24	DOCTER®unipoint 1.5 – 6 × 42	DOCTER®unipoint 2.5 – 10 × 50	DOCTER®unipoint 3 – 12 × 56	DOCTER®unipoint
<i>Reticle 0 on the second image plane</i>	<i>Reticle 0 on the second image plane</i>	<i>Reticle 0 on the second image plane</i>	<i>Reticle 0 on the second image plane</i>	<i>Bar coverage with reticle 4 – 0, bar reticle on the first image plane</i>
Magnification 1 × 22.2 cm	Magnification 1.5 × 14.8 cm	Magnification 2.5 × 8.8 cm	Magnification 3 × 7.4 cm	unipoint 1 – 4 × 24 12.0 cm
Magnification 2 × 11.1 cm	Magnification 3 × 7.4 cm	Magnification 5 × 4.4 cm	Magnification 6 × 3.7 cm	unipoint 1.5 – 6 × 42 8.0 cm
Magnification 4 × 5.5 cm	Magnification 6 × 3.7 cm	Magnification 10 × 2.2 cm	Magnification 12 × 1.8 cm	unipoint 2.5 – 10 × 50 4.8 cm
				unipoint 3 – 12 × 56 4.0 cm

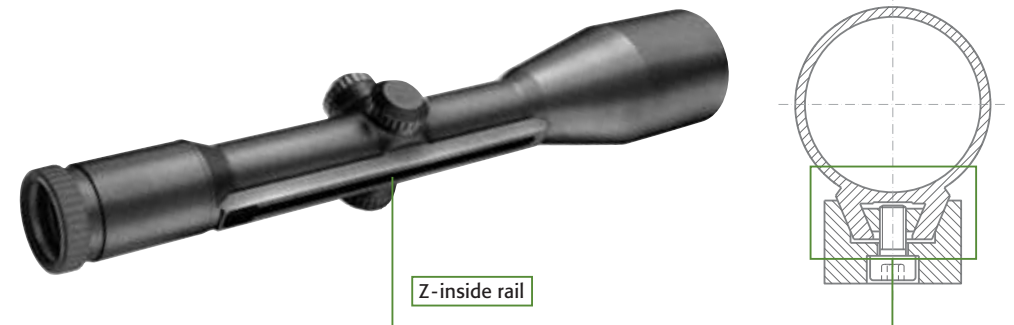

DOCTER® Reflex Sights



DOCTER®sight Reflex Sights The Original

Small. Fast. Accurate.

Reflex sights are the opto-electronic revolution in sights engineering. As an enhancement of the traditionally open sight, they unite the advantages of conventional target acquisition with optical and electronic high-tech components.

The DOCTER®sight is exemplary for the combination of a high-performance optical system with precision engineering and state-of-the-art electronics.

Developed for the fast shot, DOCTER® reflex sights fully meet the requirements on their special application. The specifically computed, patented optical system supplies a simple magnification and a clear image without distortions. The high-quality DOCTER®multitop optical system coating provides a reflex-free image, in particular under extreme lighting conditions.

The DOCTER®sight guarantees a high degree of safety during firing. Due to the single magnification, it is possible to sight with both eyes. The marksman thus obtains his maximum field of vision and an overview in all situations. The illuminated dot that is set to a parallax-free distance of 40 m assists

the marksman in safe aiming, in particular during stressful hunting situations.

The typical DOCTER® tubeless design turns these reflex sights into ideal exchangeable optical systems. As they are extremely small, light and compact they can be taken along everywhere and are quickly mounted on the weapon when they are needed.



DOCTER®sight II plus



Hunters, target shooters and authorities around the world appreciate the advantages of this reflex sight. After having been mounted thousands of times and having stood the test of time under extreme conditions, the DOCTER®sight II plus is setting standards.

The DOCTER®sight II plus unites

- instant readiness for action when the protective cap is removed,
- robust casing made of high-strength steel and hard-anodized aluminium alloys,
- two-lens high-performance optical system with internal reflex coating,
- precise, infinitely adjustable reticle adjustment without play,
- automatic control of illuminated dot intensity,
- anatomically adapted brightness progression of the illuminated dot,
- low construction height, low weight,
- easily mounted thanks to a large number of mounting adapters.

DOCTER®sight II plus

Model	3.5 MOA	7.0 MOA
Parallax balancing	40m	40m
Reticle adjustment range cm/100 m (height x side)	720 x 540	720 x 540
Illuminated dot coverage cm/100 m	10	20
Illuminated dot intensities	1	1
Dimension (l x w x h) in cm	4.6 x 2.54 x 2.37	4.6 x 2.54 x 2.37
Weight (g)	25	25

DOCTER®sight III

The Next Generation of Reflex Sights



Innovation is the road to success – this has also been true for the DOCTER®sight III. The next generation of reflex sights unites hunting, sport and tactical requirements in one appliance.

- High-strength monoblock housing made of special aluminium
- Water tight*
- Precise, infinitely adjustable reticle adjustment without play
- Two-lens high-performance optical system with internal reflex coating
- Sharp dot image across the entire field of vision thanks to additional correction lens
- Three magnet-controlled illuminated dot intensities can be selected
- Automatic illuminated dot regulation depending on the surrounding brightness
- Anatomically adapted brightness progression of the illuminated dot
- Suitable for night vision
- Battery indicator
- Control cap with safety strap eyelet
- Easily mounted thanks to a large number of mounting adapters

* in conjunction with the mounting plate

DOCTER®sight III

Model	3.5 MOA	7.0 MOA
Parallax balancing	40 m	40 m
Reticle adjustment range cm/100 m (height x side)	720 x 540	720 x 540
Illuminated dot coverage cm/100 m	10	20
Illuminated dot intensities	3	3
Dimension (l x w x h) in cm	4.6 x 2.54 x 2.37	4.6 x 2.54 x 2.37
Weight (g)	25	25

Innovation Magnetic Control

So as to be able to cope with special tasks, the DOCTER®sight III is equipped with high-performance electronic engineering in miniature format. The three-stage intensity control of the reticle brightness is effected without switch by means of an innovative operating concept. An integrated magnetic sensor reacts to the magnetic transmitter inside the control cap and triggers the reticle brightness change. Within the intensity stage set, the light sensor automatically reacts to the surrounding brightness and dims the reticle according to the physiological perceptibility of the human eye.

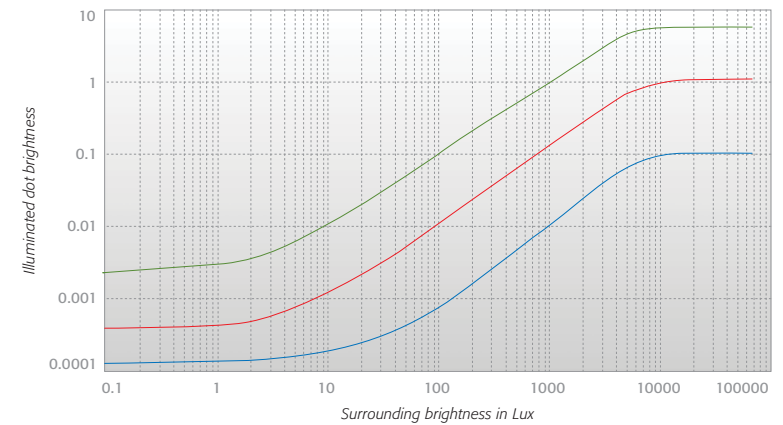

Accessories and Technical Specifications



Accessories DOCTER® Riflescopes

DOCTER® Riflescopes

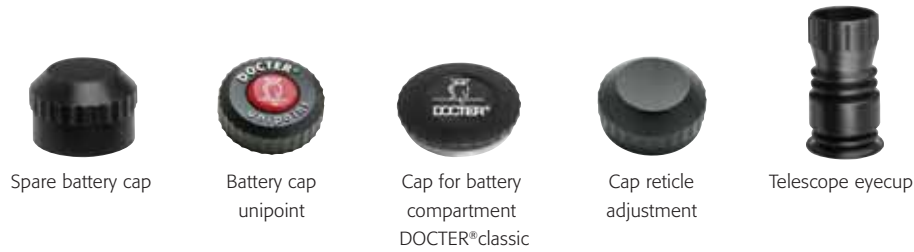

Only for DOCTER®sport

Target Turrets



Sun Visors



Accessories DOCTER® sight

DOCTER®sight: Selection of Cover Caps



DOCTER®sight: Selection of Assembly Modules

Rifles and Shotguns



Handguns



Technical Specifications at a Glance

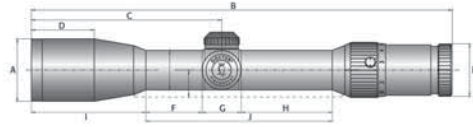

Dimensions of overall length and diameters

	A	B*	C	D	E	F	G	H	I	J	K	L
DOCTER®classic												
6×42	48	324	156	33	42	49	30	61	92	140	26	20
8×56	62	358	190	53	42	49	30	61	126	140	26	20
8×56 L	62	358	197	60	42	57	28	63	126	148	30	21
1-4×24	30	269	97	-	41	83	28	71	-	182	30	21
1.5-6×42	48	318	146	54	41	32	28	71	100	131	30	21
2.5-10×48	54	341	169	58	41	36	28	71	119	135	30	21
3-12×56	62	371	199	58	41	53	28	71	132	152	30	21
DOCTER®unipoint/DOCTER®basic												
1-4×24	30	279	102	-	41	87	30	70	-	187	30	20.7
1.5-6×42	48	323	146	48	41	43	30	70	88	143	30	20.7
2.5-10×50	56	345	168	53	41	41	30	70	112	141	30	20.7
3-12×56	62	376	199	58	41	53	30	70	131	153	30	20.7
DOCTER®comfort												
1-4×24	30	279	102	-	41	87	30	70	-	187	30	20.7
DOCTER®sport												
3-9×40	47	328	158	44	41	56	32	56	86	144	1"/25.4	-
3-10×40	47	328	158	44	41	56	32	56	86	144	1"/25.4	-
4.5-14×40	47	339	169	63	41	56	32	56	97	144	1"/25.4	-
8-25×50	57	410	239	82	41	79	32	56	144	167	1"/25.4	-

* The length specifications are measured with the diopter settings in zero position.

1. Connecting dimensions filter thread on DOCTER®sport 4.5-14×40: M 43 x 0.75
2. Connecting dimensions filter thread on DOCTER®sport 8-25×50: M 52 x 0.75
3. Connecting dimensions filter thread on DOCTER®unipoint 1-4×24: M 27 x 0.75

4. Connecting dimensions filter thread on DOCTER®unipoint 2.5-10×50: M 52 x 0.75
5. Connecting dimensions filter thread on DOCTER®unipoint 1.5-6×42: M 43 x 0.75
6. Connecting dimensions filter thread on DOCTER®unipoint 3-12×56: M 58 x 0.75

Available reticles for

DOCTER®classic									
	1	4	4A	Plex	DBA	4LP ¹⁾	SLP ²⁾	4LK ³⁾	
Bar spacing (cm/100 m)	70	70	140	100	140	70	200	70	
Bar thickness (cm/100 m)	20	12	12	12	12	12	-	12	
Line thickness (cm/100 m)	-	1.2	1.2	1.2	1.2	1.2	0.8	1.2	
Dot diameter (cm/100 m)	-	-	-	-	-	2.4	2.0	-	
DOCTER®unipoint/DOCTER®basic									
DOCTER®comfort									
	0 ⁴⁾⁵⁾⁶⁾	4-0 ⁴⁾⁵⁾⁶⁾	Circle Dot ⁴⁾⁵⁾						
DOCTER®sport									
	Plex ³⁾	Cross Hair ³⁾							

- 1) Dimmable illuminated twilight reticle illuminated dot (LP)
- 2) Dimmable illuminated twilight reticle illuminated bar dot (SLP), only for DOCTER®classic 8 x 56 extent of coverage applies to a distance of 50m; double the values for a distance of 100 m
- 3) Dimmable illuminated twilight reticle illuminated cross (LK)

- 4) Dimmable illuminated daylight reticle on the eyepiece image plane
- 5) Reticle on the 2. image plane; extent of coverage changes depending on set magnification
- 6) Reticle 0 at DOCTER®comfort 1-4×24

MODEL	Magnification	Ø Lens aperture (mm)	Ø Exit pupil (mm)	Field of view (m/100 m)	Field of view (in degrees)	Twilight performance	Adjustment per click (cm/100 m)	Max adjustment range (cm/100 m)	Dioptre adjustment range (dtp)	Ø Centre tube (mm)	Length at zero position (mm)	Mass without rail (g)	Mass with rail (g)
DOCTER®classic													
6×42	6×	42	7.0	6.6	3.8	15.9	1.0	125	±2.5	26	324	360	385
8×56	8×	56	7.0	5.0	3.0	21.2	1.0	100	±2.5	26	358	490	525
1-4×24	1× to 4×	24	15.0 6.0	27.0 10.6	15.4 6.1	2.8 9.8	2.0	320	±2.5	30	269	410	435
1.5-6×42	1.5× to 6×	42	15.0 7.0	19.1 7.1	11.0 4.0	4.2 15.9	1.0	210	±2.5	30	318	480	505
2.5-10×48	2.5× to 10×	48	15.0 4.8	12.4 4.2	7.1 2.4	7.1 21.9	1.0	125	±2.5	30	341	580	605
3-12×56	3× to 12×	56	15.0 4.7	9.0 3.5	5.1 2.0	8.5 25.9	1.0	100	±2.5	30	371	600	630
DOCTER®classic illuminated reticle													
8×56	8×	56	7.0	5.0	3.0	21.2	1.0	100	±2.5	30	358	550	570
2.5-10×48	2.5× to 10×	48	15.0 4.8	11.3 4.2	6.5 2.4	7.1 21.9	1.0	125	±2.5	30	341	620	645
3-12×56	3× to 12×	56	15.0 4.7	9.0 3.5	5.1 2.0	8.5 25.9	1.0	100	±2.5	30	371	660	685
DOCTER®basic													
1-4×24	1× to 4×	24	15.0 6.0	31.0 10.6	17.7 6.0	2.8 9.8	2.0	320	±2.5	30	279	490	-
1.5-6×42	1.5× to 6×	42	15.0 7.0	19.1 7.0	11.0 4.0	4.2 15.9	1.0	210	±2.5	30	323	560	-
2.5-10×50	2.5 to 10x	50	15.0 4.9	12.4 4.2	7.1 2.4	7.1 21.9	1.0	125	±2.5	30	345	640	-
3-12×56	3x to 12x	56	15.0 4.7	9.4 3.5	5.4 2.0	8.5 25.9	1.0	100	±2.5	30	376	680	-
DOCTER®unipoint													
1-4×24	1× to 4×	24	15.0 6.0	31.0 10.6	17.7 6.0	2.8 9.8	2.0	320	±2.5	30	279	490	510
1.5-6×42	1.5× to 6×	42	15.0 7.0	19.1 7.0	11.0 4.0	4.2 15.9	1.0	210	±2.5	30	323	560	580
2.5-10×50	2.5× to 10×	50	15.0 4.9	12.4 4.2	7.1 2.4	7.1 21.9	1.0	125	±2.5	30	345	640	660
3-12×56	3× to 12×	56	15.0 4.7	9.4 3.5	5.4 2.0	8.5 25.9	1.0	100	±2.5	30	376	680	700
DOCTER®comfort													
1-4×24	1× to 4×	24	15.0 6.0	31.0 10.6	17.7 6.0	2.8 9.8	2.0	320	±2.5	30	279	490	510
DOCTER®sport													
3-9×40	3× to 9×	40	13.3 4.2	11.4 3.9	6.5 2.2	11.0 19.0	0.7	150	±2.3	25.4	328	515	-
3-10×40	3× to 10×	40	13.3 4.0	11.4 3.8	6.5 2.2	11.0 20.0	0.7	150	±2.3	25.4	328	515	-
4.5-14×40	4.5× to 14×	40	8.9 3.1	7.8 2.6	4.5 1.5	13.4 23.7	0.7	100	±2.3	25.4	339	625	-
8-25×50	8× to 25×	50	6.3 2.0	4.4 1.5	2.5 1.0	20.0 35.4	0.35	56	±2.3	25.4	410	775	-

The following applies to all models:

- The average longitudinal eye distance (also called eye relief distance) amounts to 8 cm.
- The apertures are set to a parallax-free observation distance of 100 m. Exception is the so-called "wild boar scope". Here the parallax-free observation distance is 50 m.
- All apertures are filled with nitrogen.
- All models are water-tight when the cap is screwed on.

Subject to technical changes without notice.

Focussing life

DOCTER® – A Brand of Analytik Jena

The success of Analytik Jena AG is based on the sustained strategy to make use of a traditional location's innovative force while at the same time recognizing the growth potential of international markets.

For two decades, the quality standard has remained unchanged: "Made in Germany" is expression of an innovative force which stands simultaneously for precision, high efficiency and a long service life.

See more to understand more – with the products and instruments of Analytik Jena AG.



Analytik Jena AG
Eisfeld Branch
Seerasen 2
98673 Eisfeld/Germany

Phone: +49 (0) 36 86 37 1-11 5
Fax: +49 (0) 36 86 32 20 37

info@docter-germany.com
www.docter-germany.com

